



Catalog DC03EN

# Permanent Magnet DC

## Motors

## Drives



- DirectPower Series
- DirectPower Plus Series

- DA-Series
- SC-Series



For over 60 years, ElectroCraft has been helping engineers translate innovative ideas into reality – one reliable motor at a time. As a global specialist in custom motor and motion technology, we provide the engineering capabilities and worldwide resources you need to succeed.



This guide has been developed as a quick reference tool for ElectroCraft products. It is not intended to replace technical documentation or proper use of standards and codes in installation of product.

Because of the variety of uses for the products described in this publication, those responsible for the application and use of this product must satisfy themselves that all necessary steps have been taken to ensure that each application and use meets all performance and safety requirements, including all applicable laws, regulations, codes and standards.

Reproduction of the contents of this copyrighted publication, in whole or in part without written permission of ElectroCraft is prohibited.

Designed by media & brands · www.media-brands.de



## Table of Contents

Typical Applications . . . . .	3
Which PMDC Motor . . . . .	5
PMDc Drive Product Matrix . . . . .	6

<b>DirectPower Series</b> . . . . .	7
DP15 . . . . .	7
DP20 . . . . .	9
DP25 . . . . .	11
DP30 . . . . .	13



DP

<b>DirectPower Plus Series</b> . . . . .	15
DPP240 . . . . .	15
DPP640 . . . . .	17
DPP680 . . . . .	19
DPP700 . . . . .	21
DPP720 . . . . .	23



DPP

<b>DA-Series</b> . . . . .	25
DA43 . . . . .	25
DA47 . . . . .	27



DA

<b>SC-Series</b> . . . . .	29
SCA-L . . . . .	29
SCA-S . . . . .	31
SCA-SS . . . . .	33



SC

System Matrix . . . . .	35
Other Products . . . . .	37
Drives Accessories . . . . .	40



## Typical applications for ElectroCraft PMDC Motors:

- Custom OEM applications  
(Our Specialty)
- Antenna positioning
- Medical equipment
- Machine tool
- Material handling
- Agricultural equipemnt
- Pumps / compressors
- Door openers



## Remote Camera Operator

**Situation:** A reputable global manufacturer of film and television camera equipment for both studio and field operation required a new cost effective motor to for a next generation automatic camera development program. Considering the wide range of potential uses of the camera, the criteria required in selecting the motor for this application were extensive including wide dynamic performance, quiet, vibration free operation, combined with high reliability throughout the wide environmental range.



*And Roll'em ... The global capabilities of ElectroCraft engineering and manufacturing keep this camera tape rolling.*

**Solution:** The ElectroCraft motor design team, using a foundation of PMDC motor products with a legacy of quality and reliability, fulfilled the application requirements with a high performance PMDC motor for both the pan and tilt camera head axis that met the low noise requirement for studio work while maintaining the reliability in for the more robust outdoor environmental use, all in the same design. Our regional value-add facility in Crewe, England further refines the product by adding encoders and other shaft modifications on certain models.

**Result:** In this case, the global teams at ElectroCraft combine their efforts to provide a motor solution that meets the exact requirements of the application.

## Electric Lift

**Situation:** A manufacturer of material handling equipment required two PMDC motors to drive the independent wheels of a new electric lift vehicle. The motors need to provide high power output, be efficient on battery power and were required to be closely matched in performance to maintain optimal steering control.

**Solution:** ElectroCraft designed a custom PMDC motor with high current carrying capability to meet the stringent temperature, environmental and performance requirements of the application. Each motor is individually tuned prior to shipment in order to match the performance required for optimal steering control. The motor was also designed to operate at peak efficiency during normal operation to achieve the longest possible battery life.

**Results:** This customer has shipped thousands of electric lift vehicles around the world increasing their share in this new market space.



*A highly reliable PMDC motor lifts this manufacturer into new markets.*



*ElectroCraft and a DirectPower PMDC motor keep this customer's production, and air, moving.*

## Blower Motor

**Situation:** A manufacturer of oil burners for use in residential and commercial furnaces, boilers and water heaters required a cost effective replacement for an existing motor application due to delivery and quality issues with their existing supply chain. Due to the potential ambient temperature of the application the performance of the motor was critical as was the time in which the motor needed approval to keep shipments flowing.

**Solution:** Using an existing production design with proven performance and reliability history, ElectroCraft created a prototype with vented slots on each end cap for cooling that met the performance requirements in the initial sample. Within weeks the customer had enough motor product from ElectroCraft to meet their production and service requirements.

**Results:** The customer was able utilize the ElectroCraft Engineering capability and legacy of proven performance to exceed the delivery and performance expectations of an anxious customer.



Select your

## Permanent Magnet DC Products!



### ElectroCraft DirectPower™ Series

Sizes: 1.5, 2.0, 2.5, 3.0 inches (38, 52, 64, 77 mm)

Continuous Torque: up to 85 oz-in or 60 Ncm

- Features:
- up to 36 VDC operation
  - 2-pole design
  - Internal brush card design
  - Sealed ball bearing construction for long life and quiet operation
  - Imperial and Metric configurations
  - Motor only configuration

### ElectroCraft DirectPower™ Plus Series

Sizes: 2.25, 3.25, 4.0 Inches (57, 83, 101 mm)

Continuous Torque: up to 570 oz-in or 402 Ncm

- Features:
- up to 90VDC operation
  - 2-pole and 4-pole designs (depending on frame size)
  - Removable brushes to extend product life
  - Dynamically balanced armatures to reduce vibration
  - Imperial and metric configurations
  - Tachometer and encoder configurations available (Depending on frame size)

## PMDC Drive Product Matrix

	4 Quadrant								
	DA4303	DA4709	DA4718	SCA-LE-30-03	SCA-LS-30-03	SCA-SE-30-06	SCA-SS-30-06	SCA-SS-70-10	SCA-SS-70-30
<b>Product Description</b>									
See on page	25	27	27	29	29	31	31	33	33
<b>Power Features</b>									
Min. Voltage (VDC)	11	11	11	11	11	11	11	11	11
Max. Voltage (VDC)	30	70	70	30	30	30	30	70	70
Linear Output	●			●	●				
PWM Output		●	●			●	●	●	●
Trap Waveform		●	●			●	●	●	●
Output Frequency (kHz)		50	50			50	50	49	49
<b>Power Ratings</b>									
Peak Current		18	36					20	60
Continuous Current	3	9	18	3	3	6	6	10	30
Continuous Power (W)	75	630	1260	75	75	150	150	700	2100
<b>Control Modes</b>									
Torque Control	●	●	●		●		●	●	●
I/R Compensation	●	●	●		●		●	●	●
Speed Control using Tach	●	●	●		●		●	●	●
Speed Control using Voltage	●	●	●		●		●	●	●
Speed Control using Encoder				●		●		●	●
Analog Command (VDC)	±10	±10	±10	±10	±10	±10	±10	±10	±10
<b>Communication / Compliance</b>									
CE Compliance (LV Directive)	●	●	●	●	●	●	●	●	●
<b>Physical Enclosure</b>									
Totally Enclosed	●	●	●	●	●	●	●	●	●
Case Type	Book Shelf	Book Shelf	Book Shelf	Rack	Rack	Rack	Rack	Rack	Rack



**Still need help?**  
 Easily build your own motor at  
[www.configureamotor.com](http://www.configureamotor.com)



**Don't see exactly what you need?**  
 Have ElectroCraft build you a  
 custom winding, stack length or  
 fully customized motor... that's  
 our specialty!

## DP15: ElectroCraft DirectPower™ | PMDC Motor

Size in (mm)	Peak Torque oz-in (Ncm)	Speeds up to RPM
1.5 (38)	45 (32)	4500



### Unique Design. Exceptional Performance.

Our DirectPower DP15 PMDC motor utilize a two piece design for simplicity with needle bearing in the rear and ball bearing in front to support the load. This unique mechanical design can deliver 45 oz-in or 32 Ncm while maintaining a 1.5 inch profile.

### To build your own motor, choose the:

**1 - Frame Size**  
(Imperial or Metric)

**2 - Torque**

**3 - Winding**

**4 - Features**  
( see page 39 )

a. **DP15** — **10** — **V 12** — **000** — **X**  
 Product Name Frame Size Continuous Torque (oz-in) Voltage Rear Shaft Front Shaft Lead Option Encoder

b. **DP15M** — **07** — **V 12** — **000** — **X**  
 Product Name Frame Size Optional Metric Continuous Torque (Ncm) Voltage Rear Shaft Front Shaft Lead Option Encoder

### Step 1: DP15 & DP15M Frame Size Drawing Key

Model	MAX Length	A	B	C	D	E	F	G	H	I	J
		Front Shaft Diameter	Front Shaft Length	Pilot Diameter	Pilot Length (Ref)	Mounting Hole Pattern (Ref)	Mount Hole Spacing (Ref)	Flange External Dimension (Ref)	Rear Shaft Diameter	Rear Shaft Length	Encoder Length Single Ended Differential
DP15-10	4.03 in	0.3124 in 0.3127 in	1.00 in ±0.03	1.05 in ±0.01	0.085 in	[2] 0.180 Dia. Thru Holes	1.12 x 2.32 in	1.54 x 2.74 in	0.3124 in 0.3127 in	1.00 in ±0.04	N/A
DP15M-07	102.3 mm	8.000 mm 7.991 mm	25.4 mm ±0.76	26.67 mm ±0.25	2.16 mm	[2] 4.57 mm Dia. Thru Holes	28.4 x 58.9 mm	39.11 x 69.59 mm	8.000 mm 7.987 mm	25.4 mm ±0.76	N/A

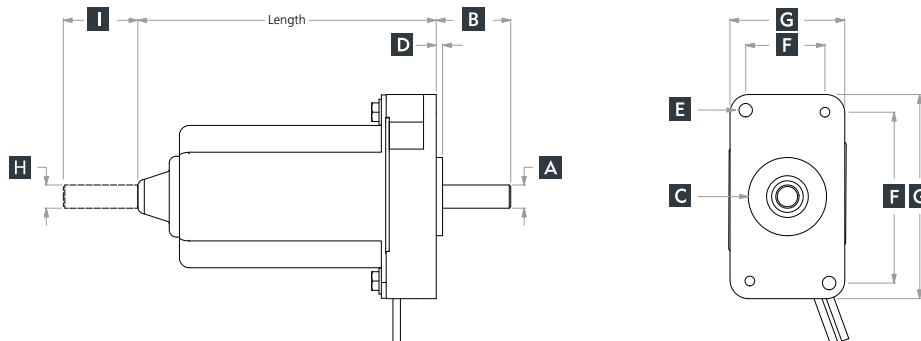



**Step 2: DP15 Torque and Mechanical Data**

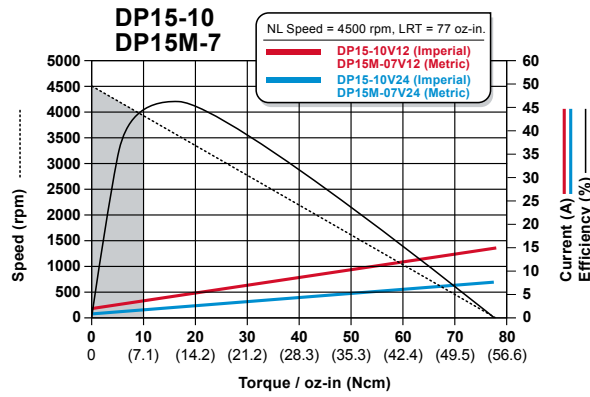

Stack Size Models	DP15-10 / DP15M-7
Cont Stall Torque oz-in (Ncm)	10 (7)
Peak Torque oz-in (Ncm)	45 (32)
No Load Speed RPM	3680
Motor Weight oz (kg)	22.4 (0.63)
Poles	2

**Step 3: Available Windings**

	10V12	10V24
Imperial	10V12	10V24
Metric	7V12	7V24
Voltage (Vdc)	12	24
Voltage Constant V/kRPM	3.2	6.4
Torque Constant oz-in/A (Ncm/A)	4.3 (3.0)	8.6 (6.0)
Max Cont Current (A)	3.7	1.9
Peak Current (A)	10.0	5.0



*Still need help?*  
 Easily build your own motor at  
**www.configureamotor.com**



*Don't see exactly what you need?*  
 Have ElectroCraft build you a custom winding, stack length or fully customized motor... that's our specialty!

## DP20 : ElectroCraft DirectPower™ | PMDC Motor

Size in (mm)	Peak Torque oz-in (Ncm)	Speeds up to RPM
2.06 (52)	72 (51)	3400



### Good-Performance. Great Price.

Our DirectPower DP20 is a conventional brush-type permanent magnet DC motor with ball bearings and non-replaceable brushes for smooth reliable operation. It provides torque up to 72 oz-in or 50.8 Ncm.

### To build your own motor, choose the:

**1 - Frame Size**  
(Imperial or Metric)

**2 - Torque**

**3 - Winding**

**4 - Features**  
( see page 39 )

a. **DP20** (Product Name, Frame Size) — **10** (Continuous Torque oz-in) — **V** **12** (Voltage) — **000** (Rear Shaft, Front Shaft, Lead Option) — **X** (Encoder)

b. **DP20M** (Product Name, Frame Size, Optional Metric) — **07** (Continuous Torque Ncm) — **000** (Rear Shaft, Front Shaft, Lead Option) — **X** (Encoder)

### Step 1: DP20 & DP20M Frame Size Drawing Key

Model	MAX Length	A	B	C	D	E	F	G	H	I	J
		Front Shaft Diameter	Front Shaft Length	Pilot Diameter	Pilot Length (Ref)	Mounting Hole Pattern (Ref)	Mount Hole Spacing (Ref)	Flange External Dimension (Ref)	Rear Shaft Diameter	Rear Shaft Length	Encoder Length Single Ended Differential
DP20-10	4.010 in	0.3124 in 0.3127 in	1.00 in ±0.03	0.984 ±0.005	0.098 in	[4] 8-32 UNC-2B 0.254 DP on 1.531 in D.B.C.	1.086	2.06 in	0.3124 in 0.3127 in	1.00 in ±0.03	N/A
DP20-15	4.663 in										
DP20-20	4.663 in										
DP20M-07	101.8 mm	8.000 mm 7.991 mm	25.4 mm ±0.76	25.0 mm ±0.13	2.5 mm	[4] M4 x 6.35 DP on 38.89 mm D.B.C.	27.5	52 mm	8.000 mm 7.987 mm	25.4 mm ±0.76	N/A
DP20M-11	118.5 mm										
DP20M-14	118.5 mm										

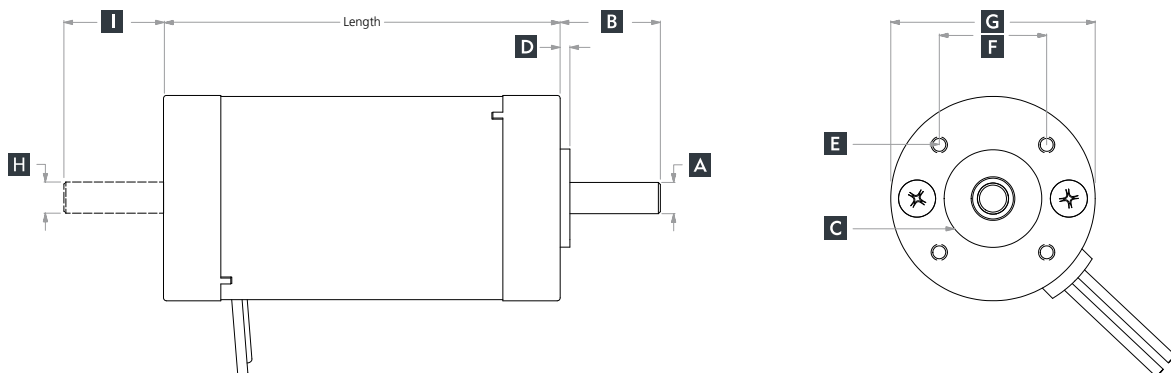

Step 2:

DP20 Torque and Mechanical Data

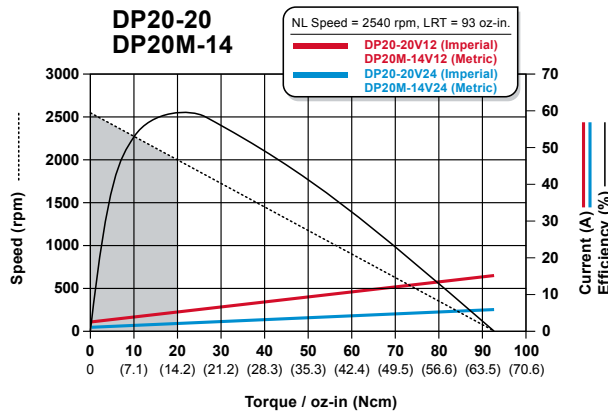
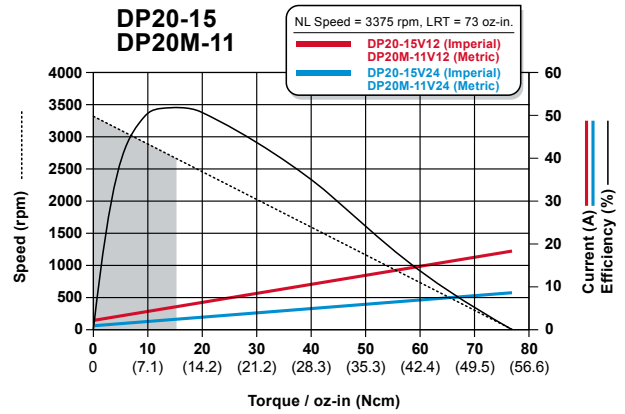
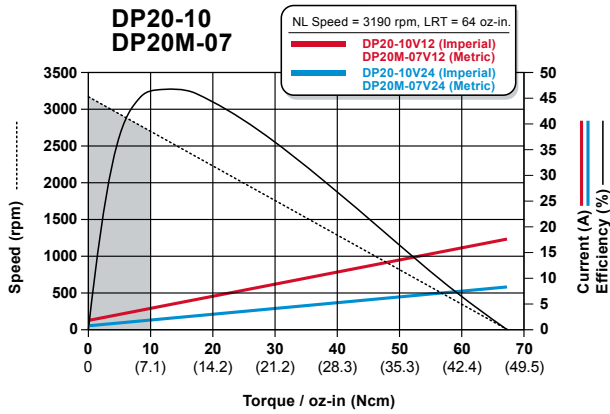

Stack Size Models	DP20-10 / DP20M-07	DP20-15 / DP20M-11	DP20-20 / DP20M-14
Cont Stall Torque oz-in (Ncm)	10 (7)	15 (11)	20 (14)
Peak Torque oz-in (Ncm)	54 (38)	63 (44)	72 (51)
No Load Speed RPM	3190	3375	2540
Motor Weight oz (kg)	32 (0.90)	35.2 (0.99)	36.8 (1.0)
Poles	2	2	2

Step 3:

Available Windings

Imperial	10V12	10V24	15V12	15V24	20V12	20V24
Metric	07V12	07V24	11V12	11V24	14V12	14V24
Voltage (Vdc)	12	24	12	24	12	24
Voltage Constant V/kRPM	3.7	7.4	4.0	7.0	4.7	9.3
Torque Constant oz-in/A (Ncm/A)	5.0 (3.5)	10.0 (7.0)	4.7 (3.3)	9.5 (6.7)	6.3 (4.4)	13.0 (9.1)
Max Cont Current (A)	3.80	1.85	4.00	1.95	4.25	2.10
Peak Current (A)	11.5	5.7	13.5	6.7	11.5	5.7

DP

## DP25 : ElectroCraft DirectPower™ | PMDC Motor

Size in (mm)	Peak Torque oz-in (Ncm)	Speeds up to RPM
2.51 (64)	215 (152)	4100



### Better-Performance. Great Price.

Our DirectPower DP25 is a conventional brush-type permanent magnet DC motor with ball bearings and non-replaceable brushes for smooth reliable operation. It provides torque up to 215 oz-in or 151.8 Ncm.

### To build your own motor, choose the:

**1 - Frame Size**  
(Imperial or Metric)

**2 - Torque**

**3 - Winding**

**4 - Features**  
( see page 39 )

a. **DP25** (Product Name) **25** (Frame Size) **30** (Continuous Torque oz-in) **V12** (Voltage) **000** (Rear Shaft, Front Shaft, Lead Option) **X** (Encoder)

b. **DP25M** (Product Name) **25** (Frame Size) **M** (Optional Metric) **21** (Continuous Torque Ncm) **V12** (Voltage) **000** (Rear Shaft, Front Shaft, Lead Option) **X** (Encoder)

### Step 1: DP25 & DP25M Frame Size Drawing Key

Model	MAX Length	A	B	C	D	E	F	G	H	I	J
		Front Shaft Diameter	Front Shaft Length	Pilot Diameter	Pilot Length (Ref)	Mounting Hole Pattern (Ref)	Mount Hole Spacing (Ref)	Flange External Dimension (Ref)	Rear Shaft Diameter	Rear Shaft Length	Encoder Length Single Ended Differential
DP25-30	4.055 in	0.3124 in 0.3127 in	1.00 in ±0.04	1.250 ±0.005	0.085 in	[4] 8-32 UNC-2B x 0.25 DP on 2.00 in D.B.C.	1.414 in	2.52 in	0.3124 in 0.3127 in	1.00 in ±0.04	N/A
DP25-35	4.553 in										
DP25-45	5.056 in										
DP25M-21	103.00 mm	8.000 mm 7.991 mm	25.4 mm ±1.0	31.75 mm ±0.13	2.16 mm	[4] M5 x 6.35 DP on 50.80 mm D.B.C.	35.91 mm	64 mm	8.000 mm 7.987 mm	25.4 mm ±1.02	N/A
DP25M-25	115.64 mm										
DP25M-32	128.42 mm										

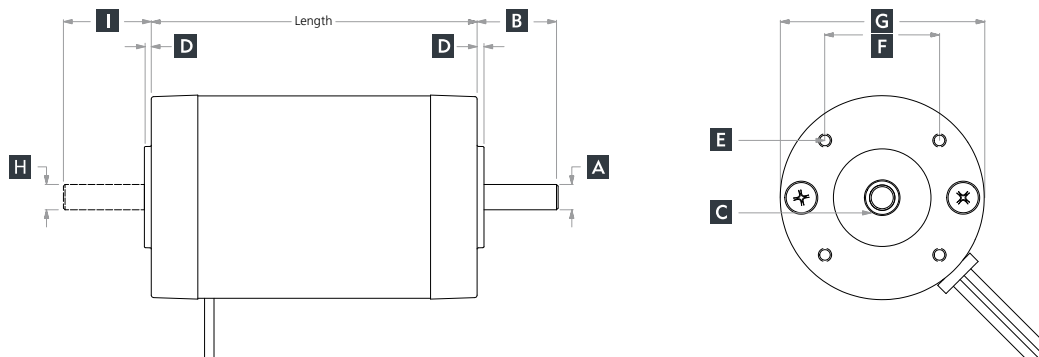

Step 2:

DP25 Torque and Mechanical Data

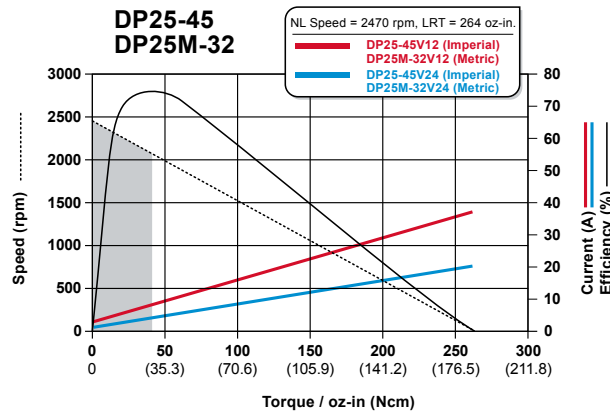
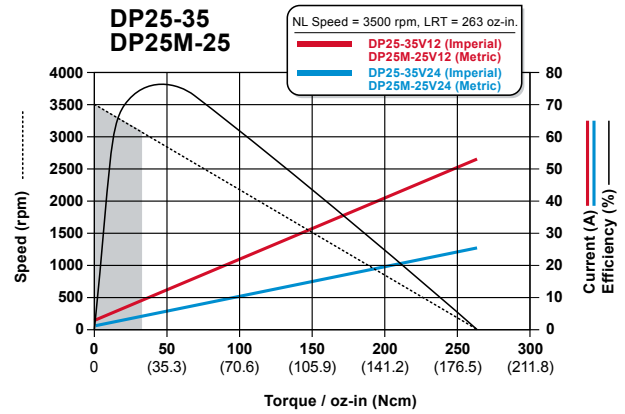
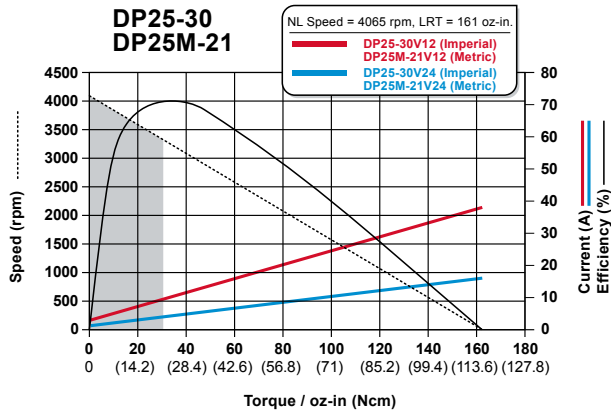

Stack Size Models	DP25-30 / DP25M-21	DP25-35 / DP25M-25	DP25-45 / DP25M-32
Cont Stall Torque oz-in (Ncm)	30 (21)	35 (25)	45 (32)
Peak Torque oz-in (Ncm)	142 (100)	180 (127)	215 (152)
No Load Speed RPM	4065	3500	2470
Motor Weight oz (kg)	41.6 (1.18)	52.8 (1.49)	62.4 (1.76)
Poles	2	2	2

Step 3:

Available Windings

Imperial	30V12	30V24	35V12	35V24	45V12	45V24
Metric	21V12	21V24	25V12	25V24	32V12	32V24
Voltage (Vdc)	12	24	12	24	12	24
Voltage Constant V/kRPM	3.28	6.56	3.50	6.96	4.90	9.70
Torque Constant oz-in/A (Ncm/A)	4.4 (3.1)	8.9 (6.2)	4.7 (3.3)	9.4 (6.6)	6.6 (4.6)	13.20 (9.3)
Max Cont Current (A)	9.2	4.6	9.5	4.8	8.0	4.0
Peak Current (A)	32.0	16.0	40.0	20.0	30.0	16.0

DP

## DP30 : ElectroCraft DirectPower™ | PMDC Motor

Size in (mm)	Peak Torque oz-in (Ncm)	Speeds up to RPM
3.03 (77)	230 (162)	1800



### Better Performance. Great Price.

Our DirectPower DP30 is a conventional brush-type permanent magnet DC motor with ball bearings and non-replaceable brushes for smooth reliable operation. It provides torque up to 230 oz-in or 162.4 Ncm.

### To build your own motor, choose the:

**1 - Frame Size**  
(Imperial or Metric)

**2 - Torque**

**3 - Winding**

**4 - Features**  
(see page 39)

a. **DP30** — **60** — **V12** — **000** — **X**  
 Product Name      Frame Size      Continuous Torque (oz-in)      Voltage      Rear Shaft      Front Shaft      Lead Option      Encoder

### Step 1: DP30 & DP30M Frame Size Drawing Key

Model	MAX Length	A	B	C	D	E	F	G	H	I	J
		Front Shaft Diameter	Front Shaft Length	Pilot Diameter	Pilot Length (Ref)	Mounting Hole Pattern (Ref)	Mount Hole Spacing (Ref)	Flange External Dimension (Ref)	Rear Shaft Diameter	Rear Shaft Length	Encoder Length Single Ended Differential
DP30-60	5.265 in										
DP30-75	5.986 in	0.3124 in 0.3127 in	1.00 in ±0.04	1.250 ±0.005	0.085 in	[4] 8-32 UNC-2B x 0.25 DP on 2.50 in D.B.C.	1.768 in	3.03 in	0.3124 in 0.3127 in	1.00 in ±0.04	N/A
DP30-85	5.986 in										

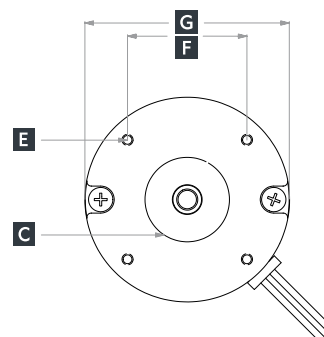
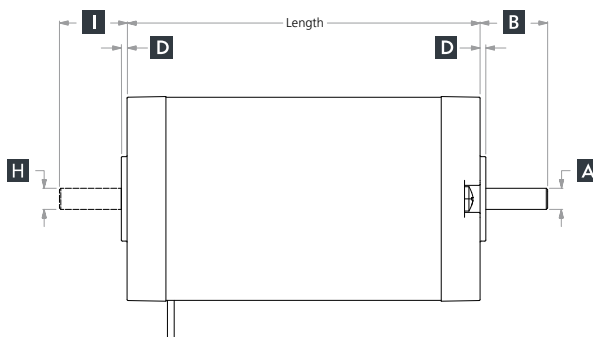

Step 2: DP30 Torque and Mechanical Data

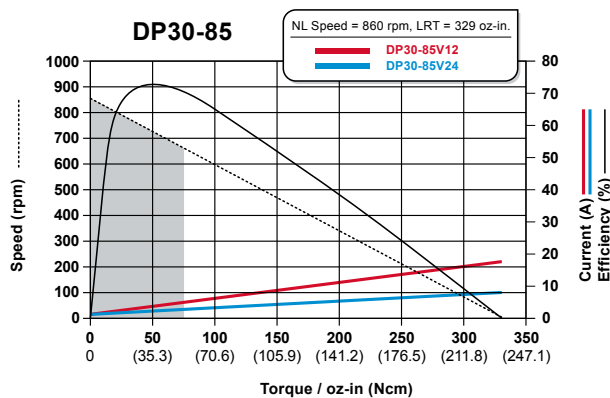
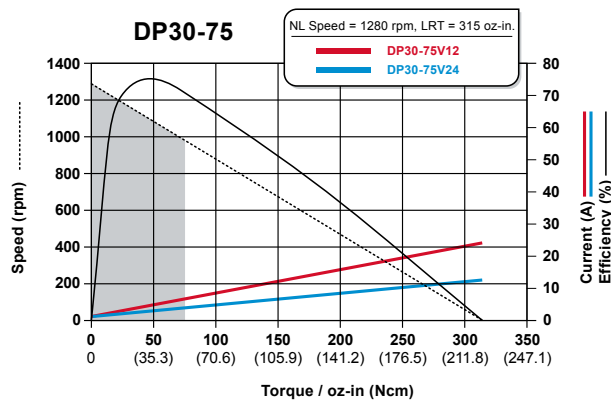
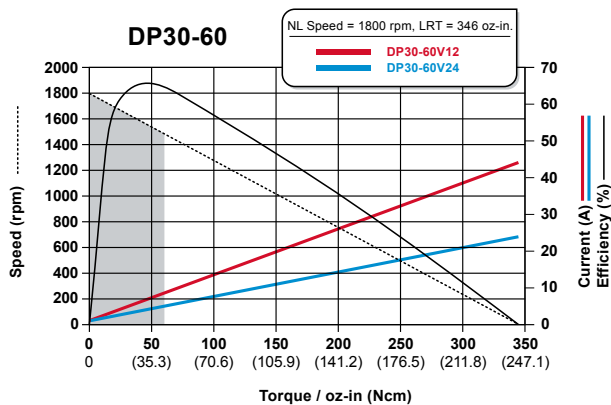

Stack Size Models	DP30-60	DP30-75	DP30-85
Cont Stall Torque oz-in (Ncm)	60 (42)	75 (53)	85 (60)
Peak Torque oz-in (Ncm)	230 (162)	180 (127)	215 (152)
No Load Speed RPM	1800	1280	860
Motor Weight oz (kg)	73.6 (2.0)	92.8 (2.6)	96 (2.7)
Poles	2	2	2

Step 3: Available Windings

Imperial	60V12	60V24	75V12	75V24	85V12	85V24
Voltage (Vdc)	12	24	12	24	12	24
Voltage Constant V/kRPM	6.50	13.10	9.00	18.00	13.60	27.10
Torque Constant oz-in/A (Ncm/A)	8.90 (6.3)	17.70 (12.5)	12.20 (8.6)	24.30 (17.2)	18.40 (13.0)	36.60 (25.8)
Max Cont Current (A)	8.7	4.4	6.6	3.3	5.0	2.5
Peak Current (A)	27.0	13.8	13.5	6.7	15.0	6.0

## DPP240 : ElectroCraft DirectPower™ Plus | PMDC Motor

Size in (mm)	Peak Torque oz-in (Ncm)	Speeds up to RPM
2.25 (57)	400 (283)	6000



### High-Torque. Long life.

Our DirectPower Plus 240 series offers reliable performance in a small package for your low voltage, lower torque range applications. This series utilizes mechanically aligned electromagnetics to provide consistent speed in either rotation. This motor includes dynamically balanced armatures, sealed ball bearings, and replaceable brushes. A low ripple tachometer option is available for speed regulation.

### To build your own motor, choose the:

**1 - Frame Size**  
(Imperial or Metric)

**2 - Torque**

**3 - Winding**

**4 - Features**  
( see page 39 )

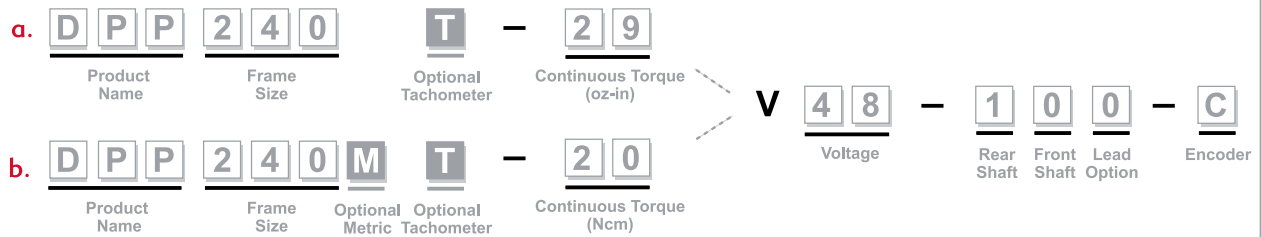

### Step 1: DPP240 & DPP240M Frame Size Drawing Key

Model	MAX Length	MAX Length (with tachometer)	A Front Shaft Diameter	B Front Shaft Length	C Pilot Diameter	D Pilot Length (Ref)	E Mounting Hole Pattern (Ref)	F Mount Hole Spacing (Ref)	G Flange External Dimension (Ref)	H Rear Shaft Diameter	I Rear Shaft Length	J Encoder Length (Ref)
DPP240	4.0 in	6.1 in	0.2500 in 0.2495 in	1.00 in ±0.03	1.000 in 0.998 in	0.10 in	[4] 6-32 UNC-2B 0.38 in Deep Min EQ SP on 1.531 in D.B.C.	1.083 in	2.00 in	0.2497 in 0.2494 in	0.70 in ±0.030	0.74 in
DPP242	5.0 in	7.1 in										
DPP243	5.5 in	7.6 in										
DPP240M	102 mm	155 mm	6.00 mm 5.99 mm	25 mm ±0.762	25.99 mm 24.94 mm	2.54 mm	[4] M4 x 0.7-6H 10 mm Deep Min EQ SP on 38.89 mm D.B.C.	27.5 mm	50.8 mm	8.00 mm 7.99 mm	19 mm ±0.381	18.8 mm
DPP242M	127 mm	179 mm										
DPP243M	140 mm	192 mm										

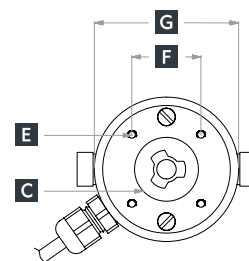
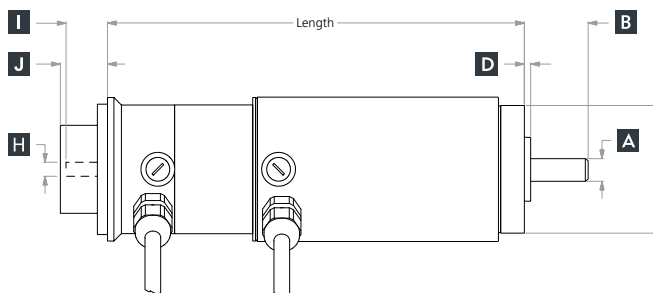



**Step 2: DPP240 Torque and Mechanical Data**

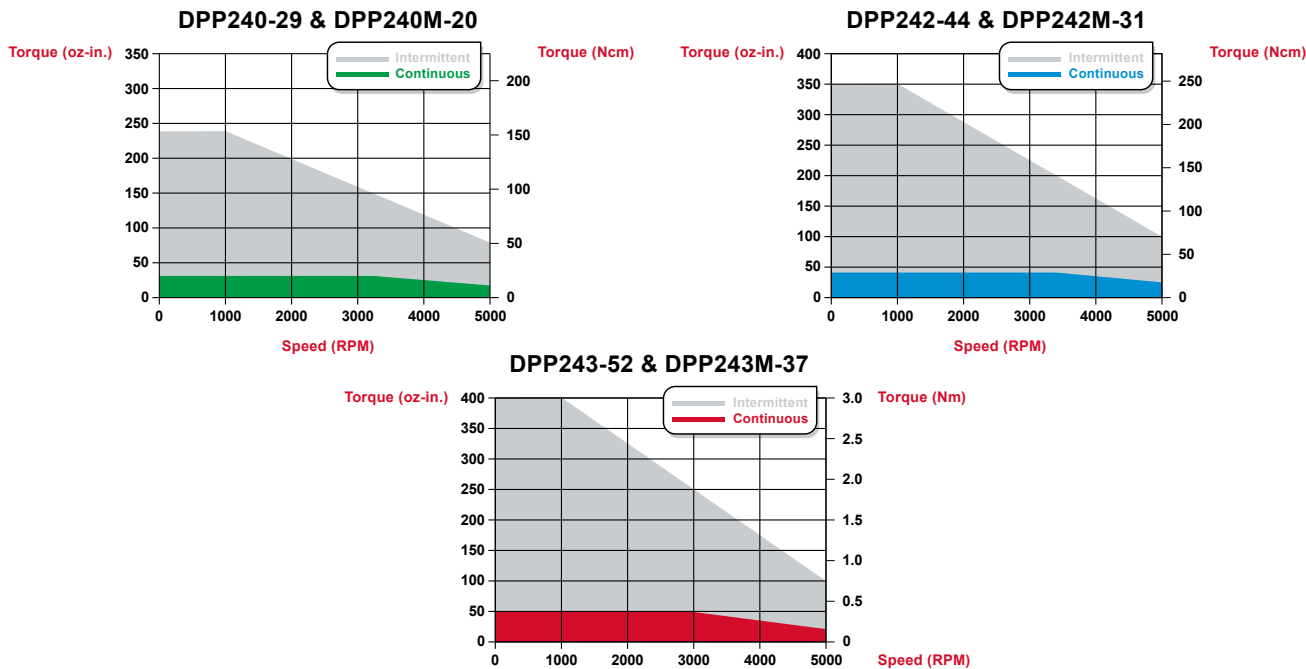

Stack Size Models	DPP240-29 / DPP240M-20	DPP242-44 / DPP242M-31	DPP243-52 / DPP243M-36
Cont Stall Torque oz-in (Ncm)	29 (20)	44 (31)	52 (36)
Peak Torque oz-in (Ncm)	240 (170)	350 (247)	400 (283)
No Load Speed RPM	5000	5000	5000
Inertia oz-in-sec <sup>2</sup> (g-cm <sup>2</sup> )	0.004 (282.5)	0.006 (423.7)	0.007 (494.3)
Motor Weight lb (kg)	2.1 (0.95)	3.0 (1.36)	3.5 (1.59)
Motor/Tach Weight lb (kg)	3.1 (1.41)	3.9 (1.77)	4.4 (2.00)

**Step 3: Available Windings**

	29V48	29V60	44V48	44V60	52V48	52V60
Imperial	29V48	29V60	44V48	44V60	52V48	52V60
Metric	20V48	20V60	31V48	31V60	36V48	36V60
Voltage (Vdc)	48	60	48	60	48	60
Voltage Constant V/kRPM	10.9	14.2	9.8	12.4	9.7	12.3
Torque Constant oz-in/A (Ncm/A)	14.7 (10.4)	19.2 (13.6)	13.3 (9.4)	16.7 (11.8)	13.1 (9.3)	16.6 (11.7)
Max Cont Current (A)	2.4	1.9	3.7	3.0	4.5	3.5
Peak Current (A)	16.3	13.9	26.7	21.2	31.9	25.3

**Optional: Tachometer Specifications**

Model	Voltage Constant V/kRPM	Tach Resistance (Ohms)	Tach Ripple Peak-Peak @ 1000 RPM	Increase Motor Inertia oz-in-sec <sup>2</sup> (g-cm <sup>2</sup> )
DPP240 Series	14.0	600-800	5%	0.0014 (98.86)

DPP

## DPP640 : ElectroCraft DirectPower™ Plus | PMDC Motor

Size in (mm)	Peak Torque oz-in (Ncm)	Speeds up to RPM
3.25 (83)	960 (678)	4500



### High-Torque. Long life.

Our DirectPower Plus 640 Series features a rugged, heavy-gauge steel housing construction for long-life and durability. This series offers smooth performance for your mid to low voltage, mid-level torque applications and features four pole construction, reduced torque ripple and optional sealed design for more aggressive application environments. A low ripple tachometer option is available for speed regulation.

### To build your own motor, choose the:

**1 - Frame Size** (Imperial or Metric)

**2 - Torque**

**3 - Winding**

**4 - Features** (see page 39)

**a.** **D P P** **6 4 2** **T** - **1 0 0** **V** **6 0** - **1 2 0** - **C**  
 Product Name Frame Size Optional Tachometer Continuous Torque (oz-in) Voltage Rear Shaft Front Shaft Lead Option Encoder

**b.** **D P P** **6 4 2 M** **T** - **7 0** **V** **6 0** - **1 2 0** - **C**  
 Product Name Frame Size Optional Metric Tachometer Continuous Torque (Ncm) Voltage Rear Shaft Front Shaft Lead Option Encoder

### Step 1: DPP640 & DPP640M Frame Size Drawing Key

Model	MAX Length	MAX Length (with tachometer)	A Front Shaft Diameter	B Front Shaft Length	C Pilot Diameter	D Pilot Length (Ref)	E Mounting Hole Pattern (Ref)	F Mount Hole Spacing (Ref)	G Flange External Dimension (Ref)	H Rear Shaft Diameter	I Rear Shaft Length	J Encoder Length (Ref)
DPP642	4.1 in	6.9 in	0.5000 in 0.4995 in	1.282 in ±0.03	3.000 in 2.997 in	0.12 in	[4] 1/4-20 UNC-2B THRU EQ SP on 3.750 in D.B.C.	2.651 in	4.25 in OD	0.3750 in 0.3747 in	0.70 in ±0.03	0.74 in
DPP643	5.7 in	8.5 in										
DPP644	6.7 in	9.5 in										
DPP642M	106 mm	175 mm	12.00 mm 11.99 mm	30 mm ±0.762	N/A	N/A	[4] M6 x 1-6H 7.62 mm Deep Min EQ SP on 63.5 mm D.B.C.	63.5 mm	78 mm OD	8.00 mm 7.99 mm	19 mm ±0.381	18.8 mm
DPP643M	146 mm	215 mm										
DPP644M	173 mm	242 mm										

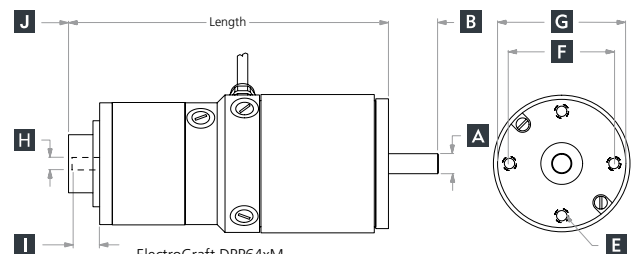
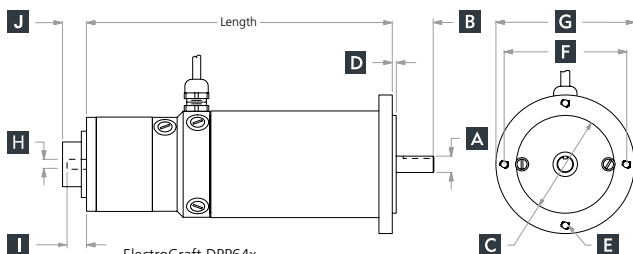

Other mounting options available upon request.

ElectroCraft DirectPower™, DirectPower™ Plus, DA-Series & SC-Series

Step 2:

DPP640 Torque and Mechanical Data

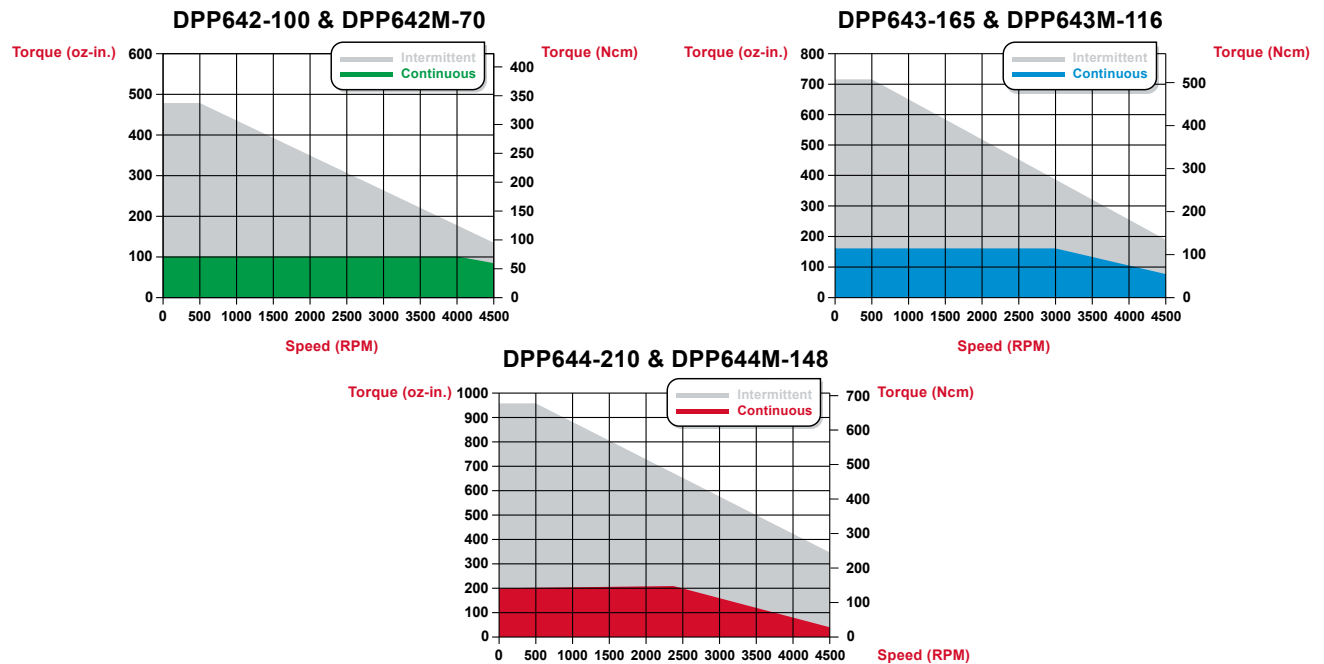

Stack Size Models	DPP642-100 / DPP642M-70	DPP643-165 / DPP643M-116	DPP644-210 / DPP644M-148
Cont Stall Torque oz-in (Ncm)	100 (70)	165 (116)	210 (148)
Peak Torque oz-in (Ncm)	480 (339)	775 (547)	960 (678)
No Load Speed RPM	4500	4500	4500
Inertia oz-in-sec <sup>2</sup> (g-cm <sup>2</sup> )	0.019 (1341.7)	0.030 (2118.5)	0.037 (2612.8)
Motor Weight lb (kg)	6.1 (2.76)	8.6 (3.90)	10.1 (4.58)
Motor/Tach Weight lb (kg)	8.0 (3.63)	10.5 (4.76)	12.0 (5.44)

Step 3:

Available Windings

	100V48	100V60	165V48	165V60	210V48	210V60
Imperial	100V48	100V60	165V48	165V60	210V48	210V60
Metric	70V48	70V60	116V48	116V60	148V48	148V60
Voltage (Vdc)	48	60	48	60	48	60
Voltage Constant V/kRPM	13.7	17.5	19.3	24.8	25.2	32.4
Torque Constant oz-in/A (Ncm/A)	18.5 (13.1)	23.6 (16.7)	26.1 (18.4)	33.5 (23.7)	34.1 (24.1)	43.8 (30.9)
Max Cont Current (A)	6.1	4.8	6.2	5.5	6.9	5.4
Peak Current (A)	25.4	19.9	29.7	23.1	28.2	21.9

Optional:

Tachometer Specifications

Model	Voltage Constant V/kRPM	Tach Resistance (Ohms)	Tach Ripple Peak-Peak @ 1000 RPM	Increase Motor Inertia oz-in-sec <sup>2</sup> (g-cm <sup>2</sup> )
DPP640 Series	14.0	80-120	5%	0.002 (141.23)

DPP

## DPP680 : ElectroCraft DirectPower™ Plus | PMDC Motor

Size in (mm)	Peak Torque oz-in (Ncm)	Speeds up to RPM
3.25 in (83)	1100 (777)	5000



### High-Torque. Long life.

Our DirectPower Plus 680 Series features a rugged, heavy-gauge steel housing construction for long-life and durability. The 680 series combines the newest winding technology with premium materials to provide an efficient product significantly extending use cycles for remotely powered applications. This motor includes dynamically balanced armatures, sealed ball bearings, and replaceable brushes.

### To build your own motor, choose the:

**1 - Frame Size** (Imperial or Metric)

**2 - Torque**

**3 - Winding**

**4 - Features** (see page 39)

a. **D P P** **6 8 1** **T** - **9 0** **V** **6 0** - **1 2 0** - **C**  
 Product Name Frame Size Optional Tachometer Continuous Torque (oz-in) Voltage Rear Shaft Front Shaft Lead Option Encoder

b. **D P P** **6 8 1 M** **T** - **6 3** **V** **6 0** - **1 2 0** - **C**  
 Product Name Frame Size Optional Metric Tachometer Continuous Torque (Ncm) Voltage Rear Shaft Front Shaft Lead Option Encoder

### Step 1: DPP680 & DPP680M Frame Size Drawing Key

Model	MAX Length	MAX Length (with tachometer)	A Front Shaft Diameter	B Front Shaft Length	C Pilot Diameter	D Pilot Length (Ref)	E Mounting Hole Pattern (Ref)	F Mount Hole Spacing (Ref)	G Flange External Dimension (Ref)	H Rear Shaft Diameter	I Rear Shaft Length	J Encoder Length (Ref)
DPP681	5.09 in	7.37 in	0.5000 in 0.4995 in	1.000 in ±0.03	1.574 in 1.572 in	0.062 in	[4] 10-32 UNC-28 0.50 in Deep Min EQ SP on 2.312 in D.B.C.	1.635 in	3.25 in OD	0.3750 in 0.3747 in	0.70 in ±0.03	0.74 in
DPP683	5.69 in	7.97 in										
DPP685	6.81 in	9.09 in										
DPP689	7.61 in	9.89 in										
DPP681M	130 mm	187 mm	12.00 mm 11.99 mm	30.0 mm ±0.762	N/A	N/A	[4] M6 x 1-6H 10 mm Deep Min EQ SP on 63.5 mm D.B.C.	44.9 mm	78 mm	8.00 mm 7.99 mm	30.0 in ±0.381	18.8 mm
DPP683M	145 mm	203 mm										
DPP685M	173 mm	231 mm										
DPP689M	194 mm	252 mm										

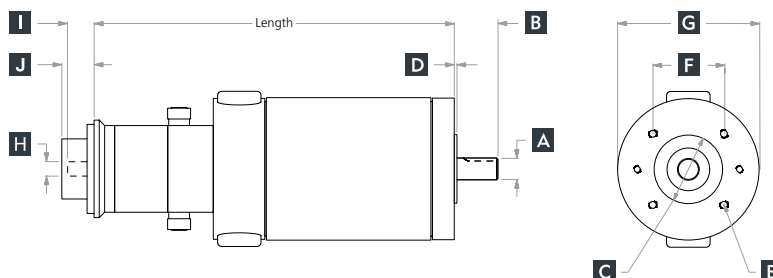

Other mounting options available upon request.

**Step 2: DPP680 Torque and Mechanical Data**

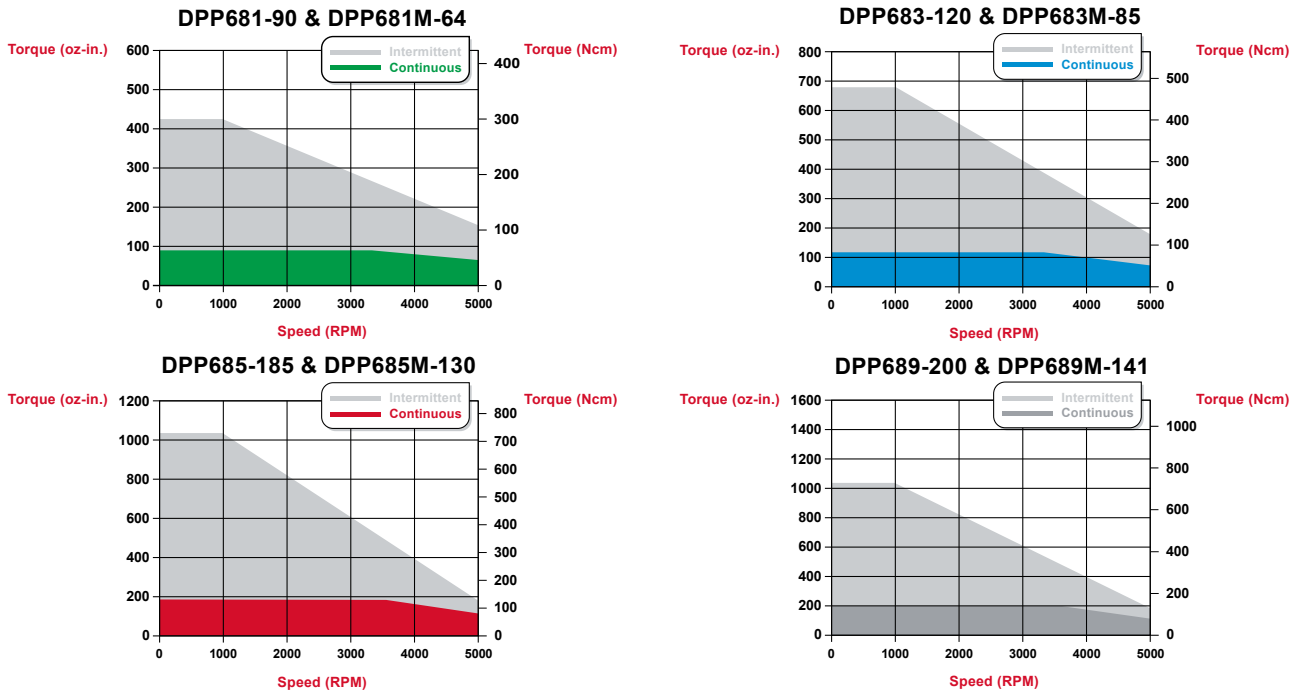

Stack Size Models	DPP681-90 / DPP681M-64	DPP683-120 / DPP683M-85	DPP685-185 / DPP685M-130	DPP689-200 / DPP689M-141
Cont Stall Torque oz-in (Ncm)	90 (64)	120 (85)	185 (131)	200 (141)
Peak Torque oz-in (Ncm)	450 (318)	680 (480)	950 (671)	1100 (777)
No Load Speed RPM	5000	5000	5000	5000
Inertia oz-in-sec <sup>2</sup> (g-cm <sup>2</sup> )	0.023 (1624.3)	0.032 (2259.8)	0.055 (3884.1)	0.068 (4802.2)
Motor Weight lb (kg)	6.0 (2.72)	6.5 (2.95)	7.0 (3.18)	8.0 (3.63)
Motor/Tach Weight lb (kg)	7.0 (3.18)	7.5 (3.40)	8.0 (3.63)	9.0 (4.08)

**Step 3: Available Windings**

Imperial	90V24	90V48	90V60	120V24	120V48	120V60	185V24	185V48	185V60	200V24	200V48	200V60
Metric	64V24	64V48	64V60	85V24	85V48	85V60	130V24	130V48	130V60	141V24	141V48	141V60
Voltage (Vdc)	24	48	60	24	48	60	24	48	60	24	48	60
Voltage Constant V/kRPM	5.2	11.1	13.4	5.6	11.2	13.6	5.4	10.8	13.0	5.5	11.0	13.8
Torque Constant oz-in/A (Ncm/A)	7.1 (5.0)	15.0 (10.6)	18.1 (12.8)	7.6 (5.3)	15.1 (10.7)	18.4 (13.0)	7.3 (5.2)	14.6 (10.3)	17.6 (12.4)	7.4 (5.2)	14.9 (10.5)	18.8 (13.3)
Max Cont Current (A)	13.0	7.3	5.9	13.0	9.0	7.7	15.0	13.8	11.2	15.0	15.0	13.7
Peak Current (A)	63.5	30.1	24.9	89.0	44.9	37.0	90.0	64.0	54.1	90.0	73.7	58.9

**Optional: Tachometer Specifications**

Model	Voltage Constant V/kRPM	Tach Resistance (Ohms)	Tach Ripple Peak-Peak @ 1000 RPM	Increase Motor Inertia oz-in-sec <sup>2</sup> (g-cm <sup>2</sup> )
DPP680 Series	14.0	600-900	5%	0.002 (141.23)

DPP

## DPP700 : ElectroCraft DirectPower™ Plus | PMDC Motor

Size in (mm)	Peak Torque oz-in (Ncm)	Speeds up to RPM
4.00 (102)	2000 (1412)	2400



### High-Torque. Long life.

Our DirectPower Plus 700 Series features a rugged, heavy-gauge steel housing construction for long-life and durability. This series offers high output for low to mid voltages, high torque applications. This high-efficiency motor includes dynamically balanced armatures, sealed ball bearings, and replaceable brushes.

### To build your own motor, choose the:

**1 - Frame Size** (Imperial or Metric)

**2 - Torque**

**3 - Winding**

**4 - Features** (see page 39)

a. **D P P 7 0 1** — **1 5 0**

Product Name Frame Size Continuous Torque (oz-in)

b. **D P P 7 0 1 M** — **1 0 6**

Product Name Frame Size Optional Metric Continuous Torque (Ncm)

**V 9 0** — **1 2 0** — **C**

Voltage Rear Shaft Front Shaft Lead Option Encoder

### Step 1: DPP700 & DPP700M Frame Size Drawing Key

Model	MAX Length	A	B	C	D	E	F	G	H	I	J
		Front Shaft Diameter	Front Shaft Length	Pilot Diameter	Pilot Length (Ref)	Mounting Hole Pattern (Ref)	Mount Hole Spacing (Ref)	Flange External Dimension (Ref)	Rear Shaft Diameter	Rear Shaft Length	Encoder Length (Ref)
DPP701	4.75 in	0.6250 in 0.6245 in	2.000 in ±0.03	2.500 in 2.497 in	0.100 in	[4] 10-32 UNC-28 0.50 in Deep Min EQ SP on 3.250 in D.B.C.	2.298 in	4.00 in OD	0.4997 in 0.4994 in	0.70 in ±0.03	0.74 in
DPP702	5.75 in										
DPP703	6.75 in										
DPP701M	121 mm	16.00 mm 15.99 mm	40 mm ±0.762	95.00 mm 94.99 mm	3.0 mm	[4] 10 mm DIA THRU EQ SP on 115 mm D.B.C.	81.32 mm	102 mm OD	12.69 mm 12.68 mm	17.78 in ±0.762	18.8 mm
DPP702M	147 mm										
DPP703M	172 mm										

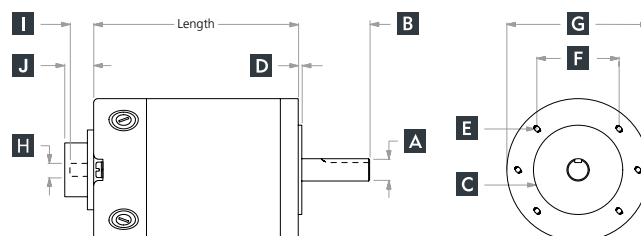

Step 2:

DPP700 Torque and Mechanical Data

DPP701-150 & DPP701M-106

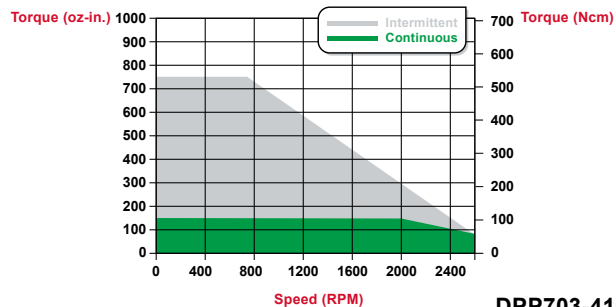

DPP702-300 & DPP702M-212

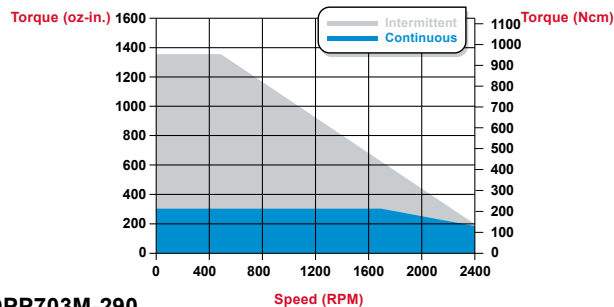

DPP703-410 & DPP703M-290

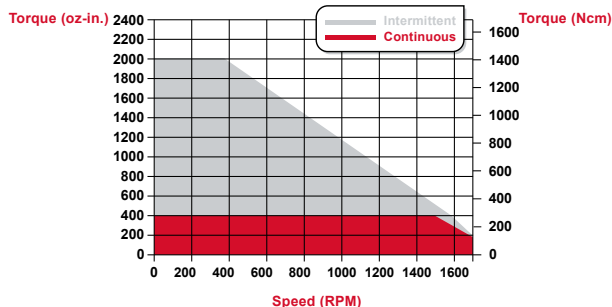

Stack Size Models	DPP701-150 / DPP701M-106	DPP702-300 / DPP702M-212	DPP703-410 / DPP703M-290
Cont Stall Torque oz-in (Ncm)	150 (106)	300 (212)	410 (290)
Peak Torque oz-in (Ncm)	750 (530)	1350 (953)	2000 (1412)
No Load Speed RPM	2400	2400	2400
Inertia oz-in-sec <sup>2</sup> (g-cm <sup>2</sup> )	0.10 (7061.6)	0.15 (10592.3)	0.20 (14123.1)
Motor Weight lb (kg)	6.1 (2.8)	8.5 (3.9)	11.0 (5.0)

DPP

Step 3:

Available Windings

Imperial	150V24	150V48	150V60	150V90	300V24	300V48	300V60	300V90	410V24	410V48	410V60	410V90
Metric	106V24	106V48	106V60	106V90	212V24	212V48	212V60	212V90	290V24	290V48	290V60	290V90
Voltage (Vdc)	24	48	60	90	24	48	60	90	24	48	60	90
Voltage Constant V/kRPM	8.4	16.4	20.4	34.8	9.1	18.7	23.0	34.4	13.7	26.5	32.9	49.3
Torque Constant oz-in/A (Ncm/A)	11.3 (8.0)	22.2 (15.7)	27.6 (19.5)	47.1 (33.3)	12.3 (8.7)	25.3 (17.9)	31.1 (22.0)	46.6 (32.9)	18.5 (13.1)	35.8 (25.3)	44.4 (31.4)	66.7 (47.1)
Max Cont Current (A)	14.8	7.5	6.0	3.4	22.0	12.9	10.4	7.1	22.0	14.2	11.4	7.4
Peak Current (A)	66.2	33.8	27.1	15.9	90.0	53.3	43.5	29.0	90.0	55.9	45.0	30.0



*Still need help?*  
 Easily build your own motor at  
[www.configureamotor.com](http://www.configureamotor.com)



*Don't see exactly what you need?*  
 Have ElectroCraft build you a  
 custom winding, stack length or  
 fully customized motor... that's  
 our specialty!

## DPP720 : ElectroCraft DirectPower™ Plus | PMDC Motor

Size in (mm)	Peak Torque oz-in (Ncm)	Speeds up to RPM
4.00 (105)	2880 (2034)	2400



### High-Torque. Long life.

Our DirectPower Plus 720 Series features a rugged, heavy-gauge steel housing construction for long-life and durability. This high-efficiency motor offers smooth and highly accurate performance across the operating speed range. It includes dynamically balanced armatures, sealed construction for reliability in most environments, sealed ball bearings, and replaceable brushes.

### To build your own motor, choose the:

**1 - Frame Size** (Imperial or Metric)

**2 - Torque**

**3 - Winding**

**4 - Features** (see page 39)

a. **D P P 7 2 6** (Product Name, Frame Size) **T** (Tachometer Standard) **3 5 5** (Continuous Torque (oz-in))

b. **D P P 7 2 6 M** (Product Name, Frame Size, Optional Metric) **T** (Tachometer Standard) **2 5 1** (Continuous Torque (Ncm))

**V 9 0** (Voltage) **1 2 0** (Rear Shaft, Front Shaft, Lead Option) **C** (Encoder)

### Step 1: DPP720 & DPP720M Frame Size Drawing Key

Model	MAX Length	A	B	C	D	E	F	G	H	I	J
		Front Shaft Diameter	Front Shaft Length	Pilot Diameter	Pilot Length (Ref)	Mounting Hole Pattern (Ref)	Mount Hole Spacing (Ref)	Flange External Dimension (Ref)	Rear Shaft Diameter	Rear Shaft Length	Encoder Length (Ref)
DPP726T	10.66 in	0.6250 in 0.6245 in	2.000 in ±0.03	3.000 in 2.997 in	0.150 in	[4] 0.390 DIA THRU EQ SP on 4.817 D.B.C.	3.406 in	4.00 in SQ	N/A	N/A	N/A
DPP727T	11.41 in										
DPP728T	12.91 in										
DPP726MT	130 mm	16.00mm 15.99 mm	40 mm ±0.762	95.00 mm 94.99 mm	3.0 mm	[4] 10 mm DIA THRU EQ SP on 115 mm D.B.C.	81.32 mm	102 mm SQ	N/A	N/A	N/A
DPP727MT	145 mm										
DPP728MT	173 mm										

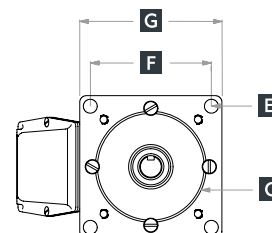
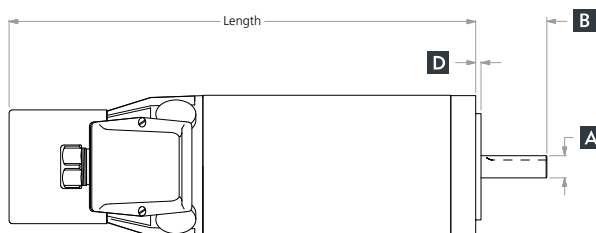



**Step 2: DPP720 Torque and Mechanical Data**

**DPP726T-355 & DPP726MT-251**

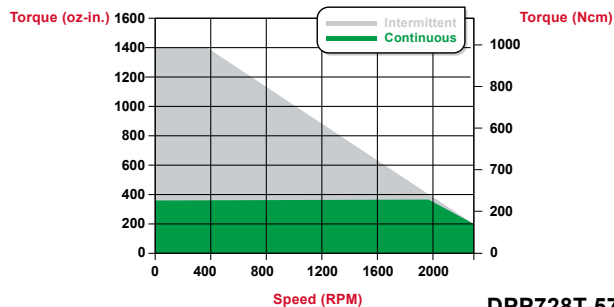

**DPP727T-455 & DPP727MT-321**

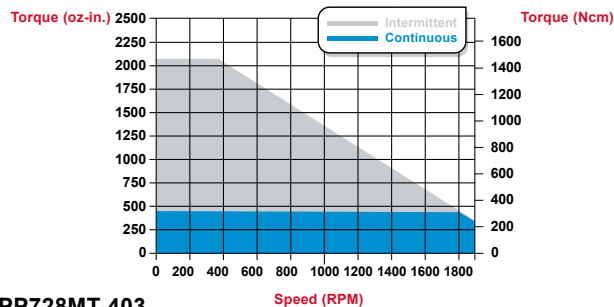

**DPP728T-570 / DPP728MT-403**

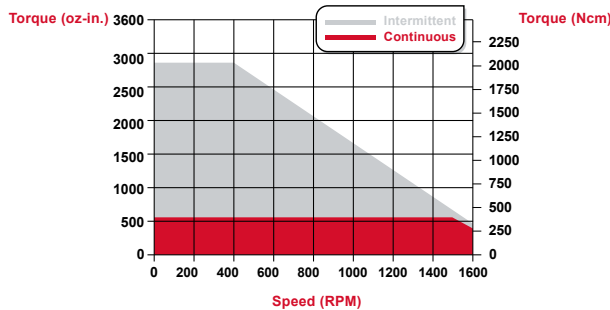

Stack Size Models	DPP726T-355 / DPP726MT-251	DPP727T-455 / DPP727MT-321	DPP728T-570 / DPP728MT-403
Cont Stall Torque oz-in (Ncm)	355 (251)	455 (321)	570 (403)
Peak Torque oz-in (Ncm)	1440 (1017)	2080 (1469)	2880 (2034)
No Load Speed RPM	2400	1900	1600
Motor / Tach Inertia oz-in-sec <sup>2</sup> (g-cm <sup>2</sup> )	0.100 (7061.6)	0.110 (7767.7)	0.175 (12357.7)
Motor Weight lb (kg)	13 (5.9)	15 (6.8)	21 (9.5)

**Step 3: Available Windings**

Imperial	355V60	355V90	355V120	455V60	455V90	455V120	570V60	570V90	570V120
Metric	251V60	251V90	251V120	321V60	321V90	321V120	403V60	403V90	403V120
Voltage (Vdc)	60	90	120	60	90	120	60	90	120
Voltage Constant V/kRPM	25.2	36.3	49.0	29.4	44.1	58.8	32.4	47.2	64.9
Torque Constant oz-in/A (Ncm/A)	34.2 (24.2)	49.2 (34.7)	66.2 (46.8)	39.8 (28.1)	59.6 (42.1)	79.5 (56.1)	43.8 (30.9)	63.8 (45.1)	87.8 (62.0)
Max Cont Current (A)	11.6	8.2	5.9	12.6	8.2	6.3	15.2	10.6	7.6
Peak Current (A)	42.1	29.3	21.7	52.3	34.9	26.2	65.6	45.1	32.8

**Tachometer Specifications**

Model	Voltage Constant V/kRPM	Tach Resistance (Ohms)	Tach Ripple Peak-Peak @ 1000 RPM
DPP720 Series	14.0	85-115	5%

DPP

## DA43 : Electrocraft CompletePower™ | Servo Amplifier

Power Supply Voltage	Nominal Current	Quadrants	Operation Mode					
			Torque Control	Analog Pos.	Speed Control			
					I x R Comp.	DC-Tacho	Voltage	Encoder
11 – 30	3	4	●		●	●	●	



### For Brush-Commutated Linear PMDC Motors. Up to 75 W.

This servo-amplifier is built into a fully enclosed rugged miniature aluminum case. Linear servo amplifiers are ideal for low friction applications requiring high bandwidth, low noise and minimal distortion from the power electronics. The drive can be configured in the following modes of operation with simple dip switch settings: I/R compensation, Tach mode, Voltage mode and Torque mode. Input power of 30 VDC combined with a mountable heat-sink provides up to 75 Watts of power. Inputs include current limit, max set value and gain functions. The drive handles continuous currents up to 3 A. The linear power stage is protected against over-current and over-temperature.

### Drive Model Example

<b>D</b> Drive Technology	<b>A</b> Version	<b>4</b> # Quadrants	<b>3</b> Voltage 10x VDC	<b>03</b> Current Amps
------------------------------	---------------------	-------------------------	-----------------------------	---------------------------

### DA43 Outline Drawing

Model	A	B	C	Weight oz (g)
	Length in (mm)	Width in (mm)	Height in (mm)	
DA4303	4.13 (105)	2.56 (65)	1.08 (28)	4.94 (140)

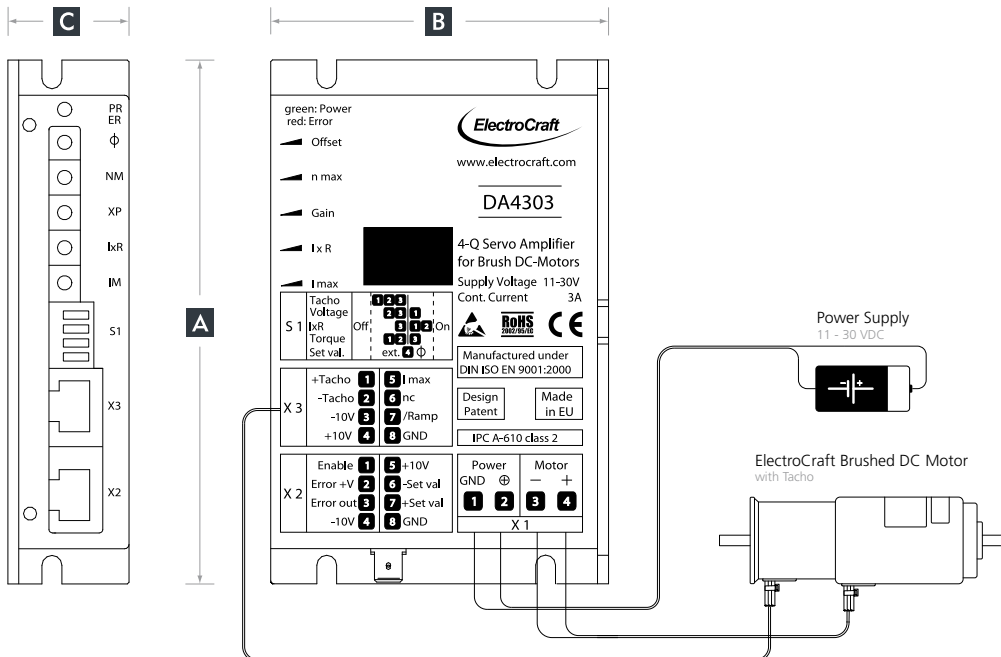

DA43 Specifications					
Model Number	Power Supply Voltage (VDC)	Aux. Voltage Verror (VDC)	Nominal Current (Amps)	Max. Power with Heatsink (Watts)	Efficiency (%)
DA4303	11 - 30	5 - 30	3	75	97
Control Inputs					
Set value			-10 to +10 VDC; Ri = 20 kOhm		
I <sub>max</sub>			0 to +10 VDC; Ri > 10 kOhm		
Tacho			max. 50 VDC; Ri = 75 kOhm		
Enable			TTL / +24 VDC; Ri = 47 kOhm		
Ramp			active LO; Ri = 100 kOhm		
Switches					
Tacho-, Voltage-, I <sub>xR</sub> -, Torque-Mode			Not set / Set		
Set value via Offset			extern / intern		
Outputs					
Auxiliary voltage source			+10 VDC / 10 mA each		
Auxiliary voltage source			+10 VDC / 10 mA each		
Error			TTL / 24 VDC; Ri = 50 Ohm		
Display					
LEDs			green = Power / red = Error		
Potentiometers					
Function of Potentiometer			Offset; n <sub>max</sub> ; Gain; I <sub>xR</sub> ; I <sub>max</sub>		
Ambient conditions					
Operation temperature (°C)			-10 to +45		
Storage temperature (°C)			-40 to +85		
Humidity Range Not Condensing (%rel)			20 to 80 % rel.		
Mode of Operation					
Speed-control by voltage		Torque-control	I <sub>xR</sub> -compensation	Speed-control by DC-tacho	

Available Accessories for DA43 (details see page 40)			
ASO-BM-70-30	CAxxxx	MA0025	WA2509
			
HA2008	HA2018	HA2028	
			

## DA47 : Electrocraft CompletePower™ | Servo Amplifier

Power Supply Voltage	Nominal Current	Quadrants	Operation Mode					
			Torque Control	Analog Pos.	Speed Control			
					I x R Comp.	DC-Tacho	Voltage	Encoder
11 - 70	9 / 18	4	●		●	●	●	



### For Brush-Commutated PMDC Motors. Up to 1260 W.

This four-quadrant PWM brush DC servo amplifier is fully enclosed in a small, rugged aluminum case which can be DIN-rail mounted or panel mounted for easy integration. The drive can be configured in the following modes of operation with simple dip switch settings: I/R compensation, Tach mode, Voltage mode and Torque mode. Both the 9 A and 18 A versions have twice the rated current available as peak current for intermittent overload conditions. This drive is protected against over-current and over-temperature and incorporates state of the art MOSFET technology for maximum efficiency. Connectivity is tool-free with RJ-45-connectors for input/outputs and push-type terminals for supply power and motor connections.

### Drive Model Example

<b>D</b> Drive Technology	<b>A</b> Version	<b>4</b> # Quadrants	<b>7</b> Voltage 10x VDC	<b>09</b> Current Amps
------------------------------	---------------------	-------------------------	-----------------------------	---------------------------

### DA47 Outline Drawing

Model	A	B	C	Weight oz (g)
	Length in (mm)	Width in (mm)	Height in (mm)	
DA4709	4.69 (119)	3.35 (85)	1.08 (28)	7.76 (220)
DA4718				

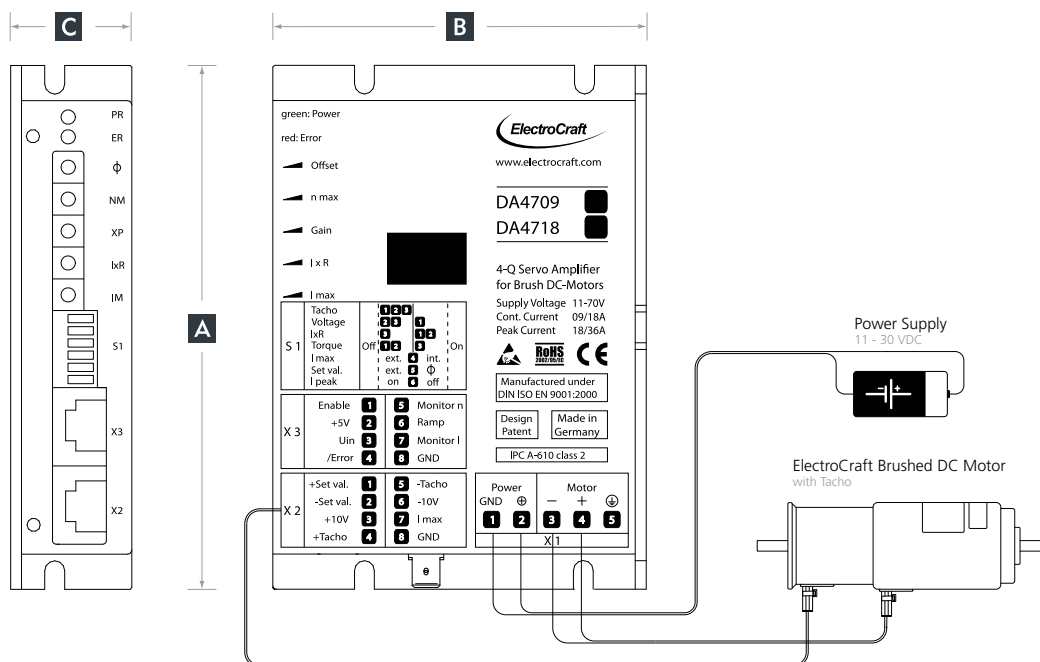

ElectroCraft DirectPower™, DirectPower™ Plus, DA-Series & SC-Series

DA47 Specifications							
Model Number	Power Supply Voltage (VDC)	Aux. Voltage Verror (VDC)	Nominal Current (Amps)	Peak current (Amps)	Max. Power with Heatsink (Watts)	Frequency of power output stage (kHz)	Efficiency (%)
DA4709	11 - 70	5 - 30	9	18	630	50	95
DA4718			18	36	1260		
Control Inputs							
Set value			-10 to +10 VDC; Ri = 20 kOhm				
Tacho			max. 50 VDC; Ri = 50 kOhm				
Enable			TTL/ +24 VDC; Ri = 4.7 kOhm				
I Limit			intern / extern				
Ramp			TTL / +24 VDC; Ri = 4.7 kOhm				
I <sub>max</sub>			0 to +10 VDC; Ri > 100 kOhm				
Switches							
Tacho-, Voltage-, I <sub>xR</sub> -, Torque-Mode			Not set / Set				
Set value via Offset			extern / intern				
I peak			on / off				
Outputs							
Auxiliary voltage source			+5 VDC / 50 mA				
Auxiliary voltage sources			±10 VDC / 20 mA				
Monitor I			1 / 0.5 V/A; Ri = 100 Ohm				
Monitor n			0.1 V / 1 Vmotor ; Ri = 100 Ohm				
Supervisory output /Error			Open Collector / Push Pull / TTL / +24V; Ri = 50 Ohm				
Display							
LEDs			green = Power / red = Error				
Potentiometers							
Function of Potentiometer			Offset; n <sub>max</sub> ; Gain; I <sub>xR</sub> ; I <sub>max</sub>				
Ambient conditions							
Operation temperature (°C)			-10 to +45				
Storage temperature (°C)			-40 to +85				
Humidity Range Not Condensing (%rel)			20 to 80 % rel.				
Mode of Operation							
Speed-control by voltage		Torque-control		I <sub>xR</sub> -compensation		Speed-control by DC-tacho	

DA

Available Accessories for DA47 (details see page 40)							
ASO-BM-70-30	IA210x	CAxxxx	HA3008	HA3018	HA3028	MA0025	WA2509
							

## SCA-L : Electrocraft CompletePower™ | Servo Amplifier

Model	Power Supply Voltage	Nominal Current	Quadrants	Operation Mode					
				Torque Control	Analog Pos.	Speed Control			
						I x R Comp.	DC-Tacho	Voltage	Encoder
SCA-LE-30-03	11 - 30	3	4						●
SCA-LS-30-03	11 - 30	3	4	●		●	●	●	



### For Brush-Commutated PMDC Motors. Up to 75 W.

This linear four-quadrant brushless DC servo amplifier is fully enclosed in a rugged aluminum case which can be panel mounted for easy integration. The drive is available in several configurations depending on your control requirements. The drive handles continuous currents up to 3 Amps and is protected against over-current, over-temperature and motor short-circuit.

### Drive Model Example



<b>SC</b> Drive Technology	<b>A</b> Case Type	<b>L</b> Drive Type	<b>E</b> Version	<b>30</b> Voltage VDC	<b>03</b> Current Amps
-------------------------------	-----------------------	------------------------	---------------------	--------------------------	---------------------------

### SCA-L Outline Drawing

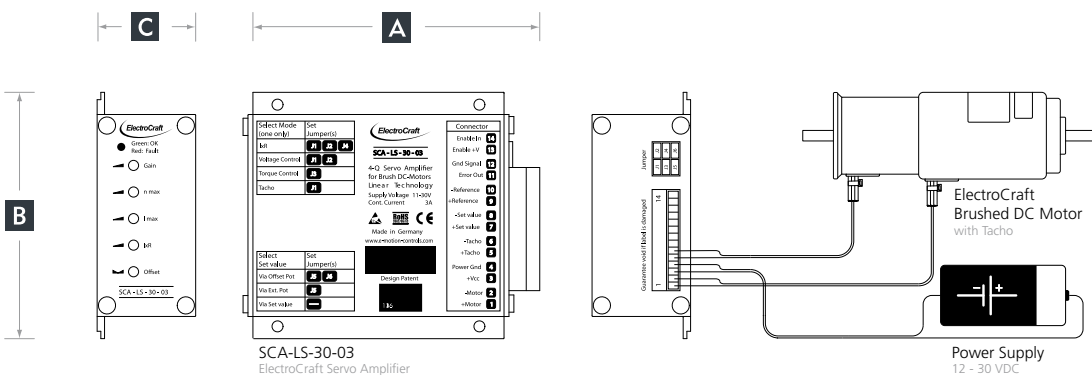
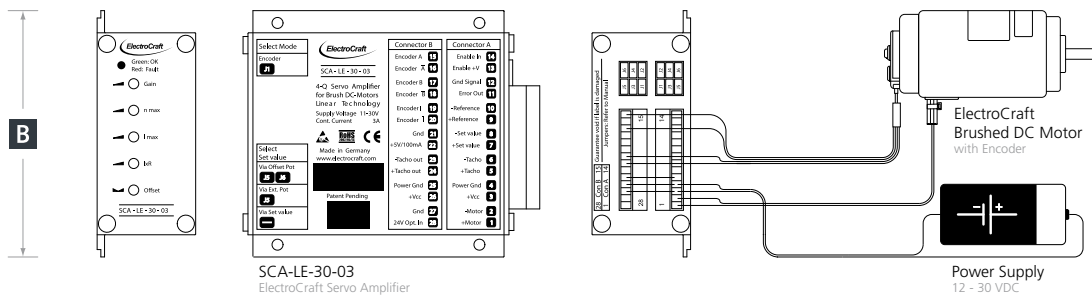
Model	A	B	C	Weight oz (g)
	Length in (mm)	Width in (mm)	Height in (mm)	
SCA-LE-30-03	4.76 (121)	3.94 (100)	1.57 (40)	13.40 (380)
SCA-LS-30-03				11.64 (330)



SCA-L Specifications			
Model Number	Power Supply Voltage (VDC)	Nominal Current (Amps)	Max. Power with Heatsink (Watts)
SCA-LE-30-03	11 - 30	3	75
SCA-LS-30-03			
Control Inputs			
Set value		-10 to +10 VDC; Ri = 100 kOhm	
Tacho		max. 50 VDC; Ri = 50 kOhm	
Enable		+8 to +30 VDC; Ri = 5 kOhm	
Encoder input signals (SCA-LE only)		Channel A & /A; B & /B; I & /I; max. 600 kHz ; TTL/ +5 to +24 VDC; Ri > 10 kOhm	
Outputs			
Auxiliary voltage source for encoder (SCA-LE only)		+5 VDC / 100 mA	
Auxiliary voltage source		+3,9 VDC / 20 mA	
Auxiliary voltage source		-3,9 VDC / 20 mA	
Auxiliary voltage source Enable +V		Connected with 4.7 kOhm to +VCC	
Error		Open Collector max. +30 VDC; 20 mA	
Display			
LEDs		green = OK / red = Fault	
Potentiometers			
Function of Potentiometer		Gain; nmax; lmax; lxR; Offset	
Ambient conditions			
Operation temperature (°C)		-10 to +45	
Storage temperature (°C)		-40 to +85	
Humidity Range Not Condensing (%rel)		20 to 80 % rel.	
Mode of Operation			
SCA-LE-30-03	Speed-control by Digital-Encoder		
SCA-LS-30-03	Speed-control by voltage	Torque-control	lxR-compensation
			Speed-control by DC-tacho

Available Accessories for SCA-L (details see page 40)	
ASO-BM-70-30	ASX-RM-01-01
	

## SCA-S : Electrocraft CompletePower™ | Servo Amplifier

Model	Power Supply Voltage	Nominal Current	Quadrants	Operation Mode					
				Torque Control	Analog Pos.	Speed Control			
						I x R Comp.	DC-Tacho	Voltage	Encoder
SCA-SE-30-06	11 - 30	6	4						●
SCA-SS-30-06	11 - 30	6	4	●		●	●	●	



### For Brush-Commutated PMDC Motors. Up to 150 W.

This PWM four-quadrant brushless DC servo amplifier is fully enclosed in a rugged aluminum case which can be panel mounted for easy integration. The drive is available in several configurations depending on your control requirements. The drive handles continuous currents up to 6 Amps and is protected against over-current, over-temperature and motor short-circuit .

### Drive Model Example

<b>SC</b>	<b>A</b>	<b>S</b>	<b>E</b>	<b>30</b>	<b>06</b>
Drive Technology	Case Type	Drive Type	Version	Voltage VDC	Current Amps

### SCA-S Outline Drawing

Model	A	B	C	Weight oz (g)
	Length in (mm)	Width in (mm)	Height in (mm)	
SCA-SE-30-06	4.76 (121)	3.94 (100)	1.57 (40)	13.76 (390)
SCA-SS-30-06				12.00 (340)

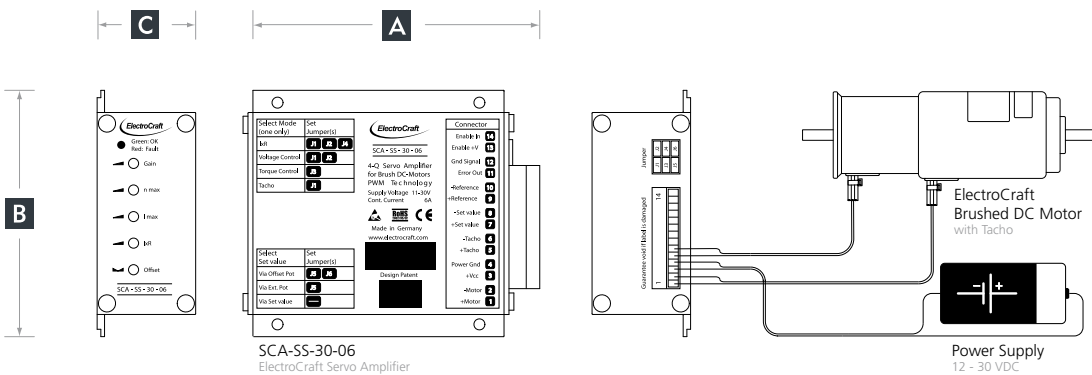
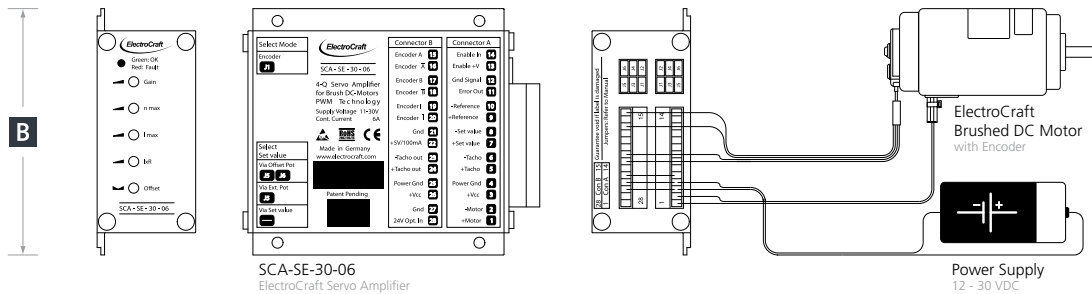



ElectroCraft DirectPower™, DirectPower™ Plus, DA-Series & SC-Series

SCA-S Specifications					
Model Number	Power Supply Voltage (VDC)	Nominal Current (Amps)	Max. Power with Heatsink (Watts)	Frequency of power output stage (kHz)	Efficiency (%)
SCA-SE-30-06	11 - 30	6	150	50	95
SCA-SS-30-06					
Control Inputs					
Set value			-10 to +10 VDC; Ri = 100 kOhm		
Tacho			max. 50 VDC; Ri = 50 kOhm		
Enable			+8 to +30 VDC; Ri = 5 kOhm		
Encoder input signals (SCA-SE only)			Channel A & /A; B & /B; I & /I; max. 600 kHz ; TTL/ +5 to +24 VDC; Ri > 10 kOhm		
Outputs					
Auxiliary voltage source			+3.9 VDC / 20 mA		
Auxiliary voltage source			-3.9 VDC / 20 mA		
Auxiliary voltage source for encoder (SCA-SE only)			+5 VDC / 100 mA		
Auxiliary voltage source Enable +V			Connected with 27 kOhm to +VCC		
Supervision output /Error			Open Collector max. +30 VDC; 20 mA		
Display					
LEDs			green = OK / red = Fault		
Potentiometers					
Function of Potentiometer			Gain; nmax; lmax; lxF; Offset		
Ambient conditions					
Operation temperature (°C)			-10 to +45		
Storage temperature (°C)			-40 to +85		
Humidity Range Not Condensing (%rel)			20 to 80 % rel.		
Mode of Operation					
SCA-SE-30-06	Speed-control by Digital-Encoder				
SCA-SS-30-06	Speed-control by voltage	Torque-control	lxF-compensation	Speed-control by DC-tacho	

Available Accessories for SCA-S (details see page 40)		
ASO-BM-70-30	ASX-RM-01-01	IA210x
		

## SCA-SS : Electrocraft CompletePower™ | Servo Amplifier

Power Supply Voltage	Nominal Current	Quadrants	Operation Mode					
			Torque Control	Analog Pos.	Speed Control			
					I x R Comp.	DC-Tacho	Voltage	Encoder
11 - 70	10 / 30	4	●	●	●	●	●	●



### For Brush-Commutated PMDC Motors. Up to 2100 W.

This PWM four-quadrant brushless DC servo amplifier is fully enclosed in a rugged aluminum case which can be panel mounted for easy integration. The drive can be configured in a variety of torque and speed control modes with the mode of operation being set by simple DIP switches. The drive handles continuous currents up to 30 Amps and provides a peak current of 60 Amps. The drive is protected against over-current, over-temperature, motor short-circuit and incorporates state of the art MOSFET technology for maximum efficiency. Connectivity is achieved with simple screw-terminals for control/feedback inputs, supply power and motor connections.

### Drive Model Example

<b>SC</b> Drive Technology	<b>A</b> Case Type	<b>S</b> Drive Type	<b>S</b> Version	<b>70</b> Voltage VDC	<b>10</b> Current Amps
-------------------------------	-----------------------	------------------------	---------------------	--------------------------	---------------------------

### SCA-SS Outline Drawing

Model	A	B	C	Weight oz (g)
	Length in (mm)	Width in (mm)	Height in (mm)	
SCA-SS-70-10	7.09 (180)	3.94 (100)	1.57 (40)	26.10 (740)
SCA-SS-70-30	7.87 (200)	3.94 (100)	3.15 (80)	40.57 (1150)

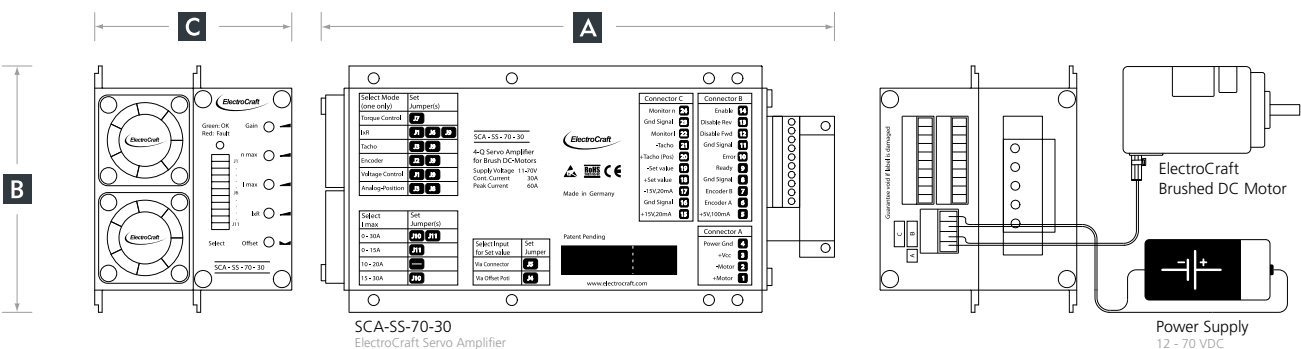
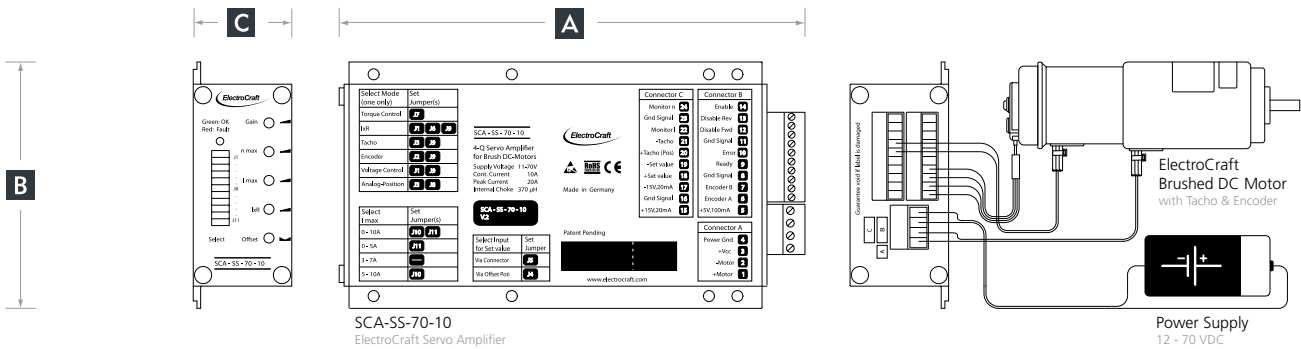

SCA-SS Specifications						
Model Number	Power Supply Voltage (VDC)	Nominal Current (Amps)	Peak current (Amps)	Max. Power with Heatsink (Watts)	Frequency of power output stage (kHz)	Efficiency (%)
SCA-SS-70-10	11 - 70	10	20	700	49	95
SCA-SS-70-30		30	60	2100		
Control Inputs						
Set v (Set value)			-10 to +10 VDC; Ri = 20 kOhm			
Encoder input signals			Channel A, B; max. 100 kHz; TTL / +5 VDC; Ri = 1kOhm			
Tacho			max. 50 VDC; Ri = 100 kOhm			
Enable			+8 to +30 VDC; Ri = 4.5 kOhm			
Disable Rev			+8 to +30 VDC; Ri = 4.5 kOhm			
Disable Fwd			+8 to +30 VDC; Ri = 4.5 kOhm			
Outputs						
Auxiliary voltage source for hall sensors			+5 VDC / 100 mA			
Auxiliary voltage source			+15 VDC / 20 mA			
Auxiliary voltage source			-15 VDC / 20 mA			
Monitor I			0.5 / 0.16 V/A ; Ri = 10 kOhm			
Monitor n			10 VDC at max. speed; Ri = 10 kOhm			
Ready			Open Collector max. +30 VDC; 20 mA			
Error			Open Collector max. +30 VDC ; 20 mA			
Display						
LEDs			green = OK / red = Fault			
Potentiometers						
Function of Potentiometer			Gain; nmax; lmax; lxF; Offset			
Ambient conditions						
Operation temperature (°C)			-10 to +45			
Storage temperature (°C)			-40 to +85			
Humidity Range Not Condensing (%rel)			20 to 80 % rel.			
Mode of Operation						
Torque-control	lxF-compensation	Speed-control by DC-tacho	Speed-control by encoder	Speed-control by voltage	Analog-positioning	

Available Accessories for SCA-SS (details see page 40)		
ASO-BM-70-30	ASX-RM-01-01	IA210x
		

## Build Your Own ElectroCraft Motor

To Fit Your Exact Application

For the past 60 years, the global team at ElectroCraft has helped engineers like you translate innovative ideas into reality. To build on that legacy, we created this Build-Your-Own ElectroCraft Motor web tool to get you started with our technology.

### GO FIGURE.

Customize your options ...

- Step 1:** Select a base technology
- Step 2:** Select a model type & features
- Step 3:** Select a performance
- Step 4:** Select an electrical winding
- Step 5:** Select any options & accessories



Easily build your own motor at  
[www.configureamotor.com](http://www.configureamotor.com)



## System Matrix - Matching Motor and Drive Combinations

Motor Series			PMDC Drive Models								
	Motor P/N		4 Quadrant								
	Imperial	Metric	DA4303	DA4709	DA4718	SCA-LE-30-03	SCA-LS-30-03	SCA-SE-30-06	SCA-SS-30-06	SCA-SS-70-10	SCA-SS-70-30
<b>DirectPower - DP</b>	DP15-10V12	DP15M-07V12		●				●	●	●	
	DP15-10V24	DP15M-07V24	●			●	●	●	●	●	
	DP20-10V12	DP20M-07V12		●				●	●	●	
	DP20-10V24	DP20M-07V24	●			●	●	●	●	●	
	DP20-15V12	DP20M-11V12		●				●	●	●	
	DP20-15V24	DP20M-11V24	●			●	●	●	●	●	
	DP20-20V12	DP20M-14V12		●				●	●	●	
	DP20-20V24	DP20M-14V24	●			●	●	●	●	●	
	DP25-30V12	DP25M-21V12			●						●
	DP25-30V24	DP25M-21V24		●				●	●		
	DP25-35V12	DP25M-25V12						●	●		●
	DP25-35V24	DP25M-25V24			●			●	●		●
	DP25-45V12	DP25M-32V12			●						●
	DP25-45V24	DP25M-32V24		●				●	●	●	
	DP30-60V12	N/A			●						●
	DP30-60V24	N/A		●				●	●	●	
	DP30-75V12	N/A		●						●	
	DP30-75V24	N/A		●				●	●	●	
DP30-85V12	N/A		●				●	●	●		
DP30-85V24	N/A		●				●	●	●		

## System Matrix - Matching Motor and Drive Combinations

	Motor Series		PMDC Drive Models								
	Motor P/N		4 Quadrant								
	Imperial	Metric	DA4303	DA4709	DA4718	SCA-LE-30-03	SCA-LS-30-03	SCA-SE-30-06	SCA-SS-30-06	SCA-SS-70-10	SCA-SS-70-30
DirectPower Plus - DDP	DPP240(T)-29V48	DPP240M(T)-20V48		●						●	
	DPP240(T)-29V60	DPP240M(T)-20V60		●						●	
	DPP242(T)-44V48	DPP242M(T)-31V48			●						●
	DPP242(T)-44V60	DPP242M(T)-31V60			●						●
	DPP243(T)-52V48	DPP243M(T)-36V48			●						●
	DPP243(T)-52V60	DPP243M(T)-36V60			●						●
	DPP642(T)-100V48	DPP642M(T)-70V48			●						●
	DPP642(T)-100V60	DPP642M(T)-70V60			●						●
	DPP643(T)-165V48	DPP643M(T)-116V48			●						●
	DPP643(T)-165V60	DPP643M(T)-116V60			●						●
	DPP644(T)-210V48	DPP644M(T)-148V48			●						●
	DPP644(T)-210V60	DPP644M(T)-148V60			●						●
	DPP681(T)-90V24	DPP681M(T)-64V24									●
	DPP681(T)-90V48	DPP681M(T)-64V48			●						●
	DPP681(T)-90V60	DPP681M(T)-64V60			●						●
	DPP683(T)-120V24	DPP683M(T)-85V24									●
	DPP683(T)-120V48	DPP683M(T)-85V48									●
	DPP683(T)-120V60	DPP683M(T)-85V60									●
	DPP685(T)-185V24	DPP685M(T)-130V24									●
	DPP685(T)-185V48	DPP685M(T)-130V48									●
	DPP685(T)-185V60	DPP685M(T)-130V60									●
	DPP689(T)-200V24	DPP689M(T)-141V24									●
	DPP689(T)-200V48	DPP689M(T)-141V48									●
	DPP689(T)-200V60	DPP689M(T)-141V60									●
	DPP701-150V24*	DPP701M-106V24*									
	DPP701-150V48	DPP701M-106V48			●						●
	DPP701-150V60	DPP701M-106V60			●						●
	DPP701-150V90*	DPP701M-106V90*									
	DPP702-300V24*	DPP702M-212V24*									
	DPP702-300V48	DPP702M-212V48									●
	DPP702-300V60	DPP702M-212V60									●
	DPP702-300V90*	DPP702M-212V90*									
	DPP703-410V24*	DPP703M-290V24*									
	DPP703-410V48	DPP703M-290V48									●
	DPP703-410V60	DPP703M-290V60									●
	DPP703-410V90*	DPP703M-290V90*									
	DPP726T-355V60	DPP726MT-251V60									●
	DPP726T-355V90*	DPP726MT-251V90*									
	DPP726T-355V120*	DPP726MT-251V120*									
	DPP727T-455V60	DPP727MT-321V60									●
DPP727T-455V90*	DPP727MT-321V90*										
DPP727T-455V120*	DPP727MT-321V120*										
DPP728T-570V60	DPP728MT-403V60									●	
DPP728T-570V90*	DPP728MT-403V90*										
DPP728T-570V120*	DPP728MT-403V120*										

\* Motor windings are optimized for a higher voltage or current than the ElectroCraft drive offering



## Other Products available from ElectroCraft:

- CompletePower™ I Motion Control
- RapidPower™ I BLDC
- TorquePower™ I Steppers
- AxialPower™ I Linear Actuator
- MobilePower™ I Transmissions
- SolidPower™ Plus I Housed AC
- SurePower™ I C-Frame AC



## CompletePower™ I Drives



With meticulous engineering and advanced electronics, our CompletePower speed controls and servo drives offer reliability and precision servo motion control. From sensitive medical dosing systems to rugged professional power tools, our CompletePower devices can handle a wide variety of applications.

---

## DirectPower™ I PMDC



Dynamically balanced armatures and precision ball bearings ensure that the DirectPower line maintains its characteristically smooth performance. This durable, totally enclosed, non-ventilated (TENV) motor is available in a broad product line from lower cost, general purpose options to high performance PMDC servo motors.

### TorquePower™ | Steppers



With non-cumulative position accuracies as low as  $\pm 3\%$ , the precision of our TorquePower motor is matched only by the dependability of its performance. Bi-directional operation and enclosed, permanently lubricated ball bearings provide long-lasting, smooth operation.

### AxialPower™ | Linear Actuator



Based on modified hybrid steppers, PMDC, and BLDC motors, our family of AxialPower linear actuators are built to last. Our unique approach to linear motion with low-friction, polymer rotating nuts and stainless steel leadscrews provides high force and linear precision in the smallest packages available.

### RapidPower™ | BLDC



Our BLDC motors provide the rapid acceleration and consistent speed needed for applications from centrifuges to x-y positioning systems. The RapidPower product line ensures a steady operation at any speed by utilizing sealed ball bearings and reduced torque ripple from skewed magnetization.

### MobilePower™ | Transmissions



With a choice of output ratios, our MobilePower line of products helps power battery-operated vehicles from wheelchairs to lift trucks. And, to increase durability and decrease noise levels, the robust all metallic gears are hobbed to a precision AGMA 9-Class.

### SolidPower™ Plus | Housed AC



High starting torques and stator windings matched to your application ensure the SolidPower product provides lasting performance. The dynamically balanced, skewed rotor bars and precision-machined fits keep vibration levels at a minimum.

### SurePower™ | C-Frame AC



Our AC shaded-pole motor, the SurePower product, can be utilized for a wide range of air-moving applications - perfect for the rigors of refrigeration and commercial food equipment applications.

## To build your own motor, choose the:

**1 - Frame Size**  
(Imperial or Metric)

**2 - Torque**

**3 - Winding**

**4 - Features**  
( see page 39 )

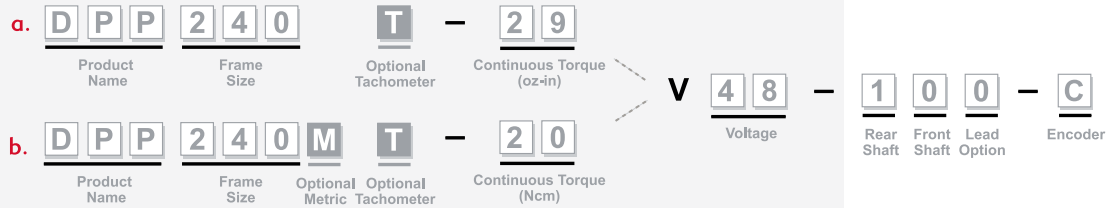

### Step 4: PMDC Motor Features

Rear Shaft	Front Shaft	Lead Option	Encoder Options (X = none)
			Differential Encoder
0 = No	0 = round	0 = flying leads	C = 500 Line
1 = Yes	1 = standard flat	1 = standard connector	D = 1000 Line
	2 = key seat		

Encoder Details (available on DPP Series only)







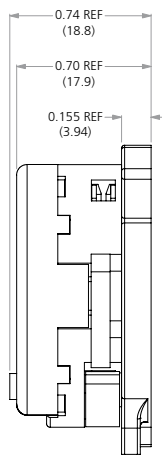





Encoder Specifications for Differential Encoder

Encoder Signals

GND	+5 VDC	CH A+	CH A-	CH B+	CH B-	CH Z+	CH Z-
-----	--------	-------	-------	-------	-------	-------	-------





Drive Accessories					
Patch Cable					
	P/N	50cm	100cm	200cm	300cm
	Red	CA2005	CA2010	CA2020	CA2030
	Yellow	CA4005	CA4010	CA4020	CA4030
	Gray	CA8005	CA8010	CA8020	CA8030
Aluminium Din Rail kit			Braking module		
	Aluminium Din Rail kit with L-shaped bracket for units: SCA-Lx / SCA-Sx (not used for SCA-SS-70-30)			Braking module in a rugged aluminium case.	
	P/N ASX-RM-01-01			P/N ASO-BM-70-30	
Passive heatsink			Passive heatsink		
	Passive heatsink optimized for drives: DA43			Passive heatsink optimized for drives: DA47	
	P/N HA2008			P/N HA3008	
fanned heatsink			fanned heatsink		
	One fan heatsink optimized for drives (fan is 1 x 24 VDC, .8 W): DA43			One fan heatsink optimized for drives (fan is 1 x 24 VDC, .8 W): DA47	
	P/N HA2018			P/N HA3018	
fanned heatsink			fanned heatsink		
	Two fan heatsink optimized for drives (fans are 2 x 24 VDC, .8 W): DA43			Two fan heatsink optimized for drives (fans are 2 x 24 VDC, .8 W): DA47	
	P/N HA2028			P/N HA3028	
Choke module			DIN Rail mounting kit		
	Choke module optimized for brushless drives. Inductance: IA2100 = 2x50 µH; IA2101 = 2x100 µH Nominal current: 10 A			DIN Rail mounting kit for units: DA43 / DA47	
	P/N IA210x			P/N MA0025	
Break Out Board			DIN Rail mounting kit		
	Break Out Board for: for DA-Series			DIN Rail mounting kit for: ASO-BM-70-30	
	P/N WA2509			P/N MA3050	

*Your Genius.  
Our Drive.*

To learn more about our products and services, please visit  
[www.electrocrafter.com](http://www.electrocrafter.com) or contact ElectroCraft today and  
see how we can help power your innovation.

#### Headquarters:

**USA:** 1 Progress Drive | Dover | New Hampshire | 03820  
Telephone: +1 603 516 1200 | Fax: +1 603 742 9080

#### Sales & Applications Engineering:

**USA:** 250 McCormick Road | Gallipolis | Ohio | 45631  
Telephone: +1 740 441 6200 | Fax: +1 740 441 6309

**Hong Kong:** Rm 1118, Delta House | 3 On Yiu Street | Shatin, NT.  
Telephone: +852 316 3225 0 | Fax: +852 316 3225 1

**Germany:** Vor dem Lauch 19 | D-70567 | Stuttgart  
Telephone: +49 (0) 711 7272 05 0 | Fax: +49 (0) 711 7272 05 44

**EMEA:** Unit 4 | Crewe Trade Park | Crewe | Cheshire | CW1 6JT, UK  
Telephone: +44 (0) 127 0580 14 2 | Fax: +44 (0) 127 0251 24 0

